

AVerMedia® AVerDiGi EB1304 NET

Operation Manual



FCC NOTICE (Class B)



This device complies with Part 15 of the FCC Rules. Operation is subject to the following two conditions: (1) this device may not cause harmful interference, and (2) this device must accept any interference received, including interference that may cause undesired operation.

Federal Communications Commission Statement

NOTE- This equipment has been tested and found to comply with the limits for a Class B digital device, pursuant to Part 15 of the FCC Rules. These limits are designed to provide reasonable protection against harmful interference when the equipment is operated in a commercial environment. This equipment generates, uses and can radiate radio frequency energy and, if not installed and used in accordance with the instructions, may cause harmful interference to radio communications. Operation of this equipment in a residential area is likely to cause harmful interference in which case the user will be required to correct the interference at his own expense.

CAUTION ON MODIFICATIONS

To comply with the limits for the Class B digital device, pursuant to Part 15 of the FCC Rules, this device must be installed in computer equipment certified to comply with the Class B limits. All cables used to connect the computer and peripherals must be shielded and grounded. Operation with non-certified computers or non-shielded cables may result in interference to radio or television reception.

Changes and modifications not expressly approved by the manufacturer could void the user's authority to operate this equipment.

European Community Compliance Statement (Class B)



This product is conformity with the protection requirements of EU Council Directives 89/336/EEC amended by 92/31/EEC on the laws of the Member States relating to electromagnetic compatibility.

Warning - This is a Class B product. In a domestic environment this product may cause radio interference in which case the user may be required to take adequate measures to correct this interference.

DISCLAIMER

No warranty or representation, either expressed or implied, is made with respect to the contents of this documentation, its quality, performance, merchantability, or fitness for a particular purpose. Information presented in this documentation has been carefully checked for reliability; however, no responsibility is assumed for inaccuracies. The information contained in this documentation is subject to change without notice.

In no event will AVerMedia be liable for direct, indirect, special, incidental, or consequential damages arising out of the use or inability to use this product or documentation, even if advised of the possibility of such damages.

TRADEMARKS

AVerMedia, being authorized AVerMedia Information, Inc. to use, is registered trademarks of AVerMedia TECHNOLOGIES, Inc. IBM PC is a registered trademark of International Business Machines Corporation. Macintosh is a registered trademark of Apple Computer, Inc. Microsoft is a registered trademark and Windows is a trademark of Microsoft Corporation. All other products or corporate names mentioned in this documentation are for identification and explanation purposes only, and may be trademarks or registered trademarks of their respective owners.

COPYRIGHT

© 2008 by AVerMedia TECHNOLOGIES, Inc. All rights reserved. No part of this publication may be reproduced, transmitted, transcribed, stored in a retrieval system, or translated into any language in any form by any means without the written permission of AVerMedia TECHNOLOGIES, Inc.



The mark of Crossed-out wheeled bin indicates that this product must not be disposed of with your other household waste. Instead, you need to dispose of the waste equipment by handing it over to a designated collection point for the recycling of waste electrical and electronic equipment. For more information about where to drop off your waste equipment for recycling, please contact your household waste disposal service or the shop where you purchased the product.

Battery Safety Information

- Store the batteries in a cool dry place.
- Do not dispose of used batteries in domestic waste. Dispose of batteries at special collection points or return to point of sale if applies.
- Remove the batteries during long periods of non-use. Always remove exhausted batteries from the remote control. Battery leakage and corrosion can damage this remote control, dispose of batteries safely.
- Do not mix old and new batteries.
- Do not mix different types of batteries: alkaline, standard (carbon-zinc) or rechargeable (nickel-cadmium).
- Do not dispose of batteries in a fire. The batteries may explode or leak.
- Never short circuit the battery terminals.

**WARNING**

TO REDUCE RISK OF FIRE OR ELECTRIC SHOCK, DO NOT EXPOSE THIS APPLIANCE TO RAIN OR MOISTURE

**CAUTION**

IF THERE IS ANY DAMAGE, SHORTAGE OR INAPPROPRIATE ITEM IN THE PACKAGE, PLEASE CONTACT WITH YOUR LOCAL DEALER. WARRANTY VOID FOR ANY UNAUTHORIZED PRODUCT MODIFICATION

**NOTICE**

- INFORMATION IN THIS DOCUMENT IS SUBJECT TO CHANGE WITHOUT NOTICE.
- THE INFORMATION CONTAINED HEREIN IS TO BE CONSIDERED FOR REFERENCT ONLY.

**LIGHTNING WARNING**

- TO AVOID THE LIGHTNING STRIKE, STRONGLY SUGGEST INSTALLING THE LIGHTNING ROD AT LIGHTNING FREQUENTLY AREA.
- FOR ADDED PROTECTION, UNPLUG THE DVR UNIT DURING THE LIGHTNING STORM. THIS MAY PREVENT TO DAMAGE THE DVR UNIT DUE TO THE LIGHTNING.

Table of Contents

Chapter 1 Introduction.....	1
1.1 Package Content.....	1
1.2 Features and Specifications	1
1.3 Front Panel.....	2
1.4 Back Panel	2
1.5 Setting Up the DVR Unit.....	3
1.5.1 Installing the Hard Disk	3
1.5.2 Connecting Devices	5
1.5.3 Connecting the Sensor/Relay device	6
1.5.3.1 I/O Card Sensor and Relay pinhole allocation:.....	6
Chapter 2 Operating the EB1304 NET	7
2.1 Familiarizing the Remote Control Buttons	7
2.1.1 Using AB Repeat Function	8
2.1.2 Using USB Backup Button	8
2.2 Using the EB1304 NET for the First Time.....	9
2.2.1 Set up the System Date and Time	9
2.3 Surveillance Screen	10
2.4 Playback the Video.....	10
Chapter 3 OSD Navigation Tree	12
3.1 Menu Function.....	13
Chapter 4 Using the USB Playback Console.....	22
4.1 Recommended system requirements.....	22
4.2 Installing the USB Playback Console	22
4.3 Running the USB Playback Console	23
4.3.1 To Cut and Save the Portion of the Recorded Video.....	25
4.3.2 Playback DVR Recorded File from Hard Disk.....	25
4.3.3 Playback Backup File(*.dvr).....	25
Chapter 5 Backup Recorded Video File	27
5.1 Familiarizing with HDD Backup Application	27
5.2 To Backup Recorded Video File	28
Chapter 6 ImageVerification.....	29
6.1 To Run the ImageVerification.....	29
Chapter 7 iEnhance.....	30
7.1 To Use iStable	31
Chapter 8 Using the Remote Programs	32
8.1 Familiarizing the Web Viewer Buttons	33
8.1.1 To Setup Remote System Setting	34

8.1.1.1	Camera Setup	34
8.1.1.2	Record Setup	35
8.1.1.3	Alarm/Sensor Setup	36
8.1.1.4	Network Setup.....	37
8.1.1.5	Password Change	39
8.2	Familiarizing the Remote Console Buttons.....	40
8.2.1	To Setup Remote Console Setting	41
8.3	Using the Remote Playback	42
8.3.1	Familiarizing the Local Playback Buttons.....	43
8.3.1.1	To Cut and Save the Wanted Portion of the Recorded Video.....	44
8.3.2	Familiarizing the Download and Playback Buttons	45
Chapter 9	Using Central Management System	46
9.1	Software Installation	46
9.1.1	Minimum System Requirements	47
9.2	Installing the CM3000 in Windows XP/2000.....	47
9.3	Using the CM3000.....	48
9.3.1	Running the CM3000 Software	48
9.3.2	Using the CMS Application	49
9.4	Customizing the CMS System.....	51
9.4.1	System Setting.....	51
9.4.1.1	To change the Alarm Record Storage Path	51
9.4.1.2	To Set the System to a Different Language.....	52
9.4.1.3	To Change the Status Date Format	52
9.4.2	DVR Setup.....	52
9.4.2.1	To Add and Remove DVR Server	53
9.4.3	Camera Setup.....	53
9.4.4	E-MAP Setup	54
9.4.4.1	To Set Up the E-Map	54
9.4.4.2	To Use the E-Map.....	57
9.4.5	Alarm Setting	58
9.4.5.1	To setup an alarm condition.....	58
9.4.6	User Setting	60
9.4.6.1	To Set the User Setting	61
9.5	Using the Playback Function	61
9.5.1	To Playback the video	61
9.5.2	Using the Local Playback Application	62
9.5.3	Using the Remote Playback Application	63
9.5.3.1	To Cut and Save the Wanted Portion of the Recorded Video.....	64
9.5.3.2	To Search Using the Visual Search	64
9.5.3.3	To Search Using the Event Search.....	65

9.5.3.4 To Search Using the Intelligent Search	65
9.5.4 Using the Event Viewer.....	66
Appendix A Registering Domain Names.....	67
Appendix B Dual Monitors setting	68
Graphic card with ATi chipset.....	68
Graphic card with NVIDIA chipset.....	70
Appendix C Network Service Port.....	71

Chapter 1 Introduction

1.1 Package Content

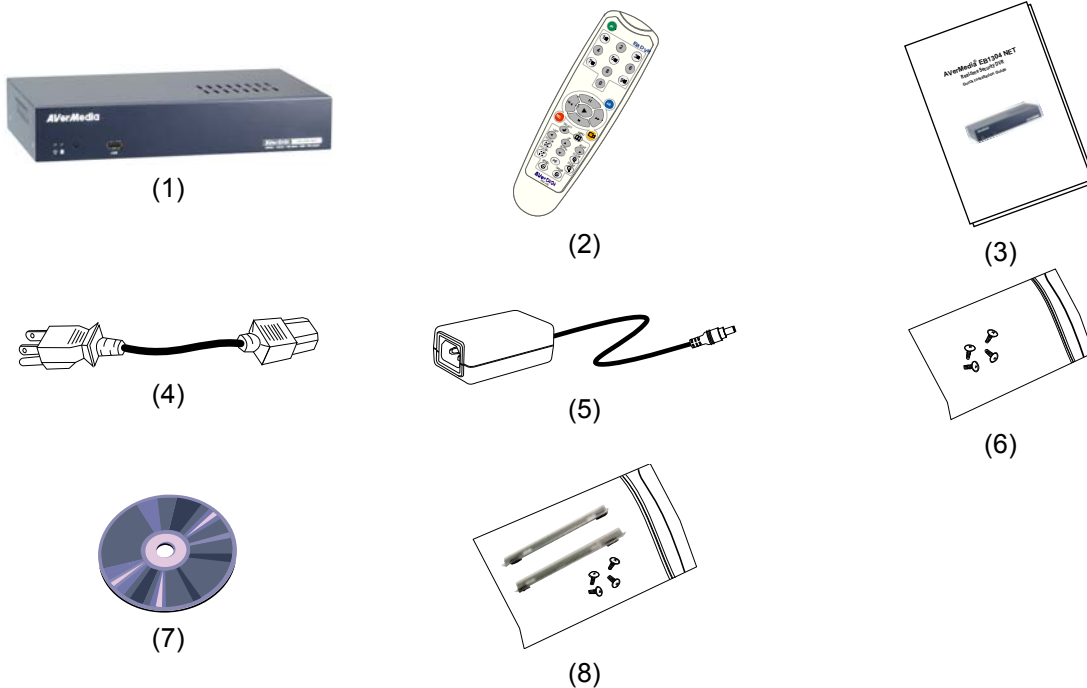

- (1) AVerDiGi EB1304 NET unit
- (2) Remote Control (batteries included)
- (3) Quick Installation Guide
- (4) Power Cord
 - * The power cord varies depending on the standard power outlet of the country where it is sold.
- (5) Power Adapter
- (6) Accessories (screws for HDD installation)
- (7) Software CD (User Manual included)
- (8) HDD holder (4 screws are included)



1.2 Features and Specifications

- Non-PC stand-alone network digital video recorder
- 4 composite video inputs and 1 composite output
- VGA output for LCD or CRT monitor display
- On Screen Display(OSD) control menu
- MPEG4 video compression
- Auto-detect NTSC or PAL video system
- Support Web viewer on Internet Explorer
- Support Central Management System(CMS)
- Support remote console
- Support USB backup to pen drive and external hard disk
- Support network, playback, and recording simultaneously

- Supports 1 hard disk drive (not included)
- Full-screen resolution:
Display: 720 x 480 (NTSC) / 720 x 576 (PAL)
Recording: 720 x 480 (NTSC) / 720 x 576 (PAL)
- Recording frame rate:
D1 mode: 60fps(NTSC) / 50fps (PAL)
CIF mode: 120 fps (NTSC) / 100fps (PAL)
- Scheduled recording (00:00~23:00 set by hour)
- Search for recorded video files by date/time/event
- Input/Output: 4 sensor inputs and 1 relay output control
- Multiple language operation screens

1.3 Front Panel



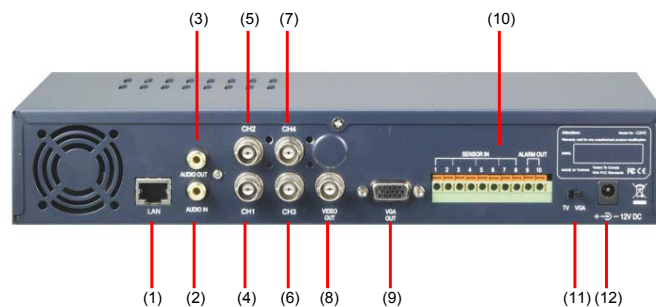

Name	Function
(1) DVR Power LED 	Light when the unit is power on
(2) HDD LED 	Indicate the hard disk running state. Light when the HDD is running (Read/Write)
(3) IR Sensor	Receive signal from the remote control to operate the unit
(4) USB 2.0 Port	Connect to pen drive / external hard disk for backup
<p> - If the external hard disk is first time using, please format to FAT32 format.</p> <p>- The DVR system supports external hard disk capacity up to 32GB.</p>	

1.4 Back Panel



Name	Function
(1) RJ-45 port	Ethernet connection port
(2) Audio In	Input the audio signal from audio output device which it has a power supply by itself. The audio is embedded with channel 1
<p> The audio input device needs to be powered by external power.</p>	

Name	Function
(3) Audio Out	Output the audio signal to a audio out device which it has a power supply by itself
	 The audio output device needs to be powered by external power.
(4) CH1	Input the video camera signal and display it on channel 1
(5) CH2	Input the video camera signal and display it on channel 2
(6) CH3	Input the video camera signal and display it on channel 3
(7) CH4	Input the video camera signal and display it on channel 4
(8) Video Out	Output the video signal to other vedio output device through BNC port
	 The DVR unit support 2 video output ports and you can only select to output the video either from the VGA OUT or VIDEO OUT
(9) VGA OUT	Output the video signal to a CRT or LCD monitor
(10) Sensor In & Alarm Out	Support up to 4 sensor device and 1 relay device (Relay: 1A @ 125V AC/30V DC)
(11) TV-VGA Switch	Switch to select the video output. Make sure to set the video output before turning on the unit
(12) 12V DC	Connect the power adapter into this port

1.5 Setting Up the DVR Unit

1.5.1 Installing the Hard Disk

The DVR unit allows user to install one hard disk. Before installing the hard disk, make sure to set the hard disk master jumper setting. Adjust the jumper setting according to the instructions on the hard disk label.



For hard disk spec, please referring to http://www.avermedia.com/nvd/hardware-recom_eb_c.asp



The “compatible hard disks” indicated in the above recommendation list only means that these commercially available hard disks were tested with AVerMedia products and functioned well under normal operation conditions. AVerMedia does not guarantee or provide warranties, explicitly, implied or statutory with respect to the reliability of the hard disk function or its compatibility. In no event AVerMedia shall be liable for damages, with respect to any business interruption of clients, lost profits, loss of programs or other data on your information handling system or otherwise. This includes direct, indirect, incidental, special, or consequential damages, resulting from the incompatibility caused by the usage of these hard disks, even if AVerMedia has expressly advised about the risk of such damages. The entire risk arising out of the use of any information attached here with is borne by the recipient.

Follow the illustrated instructions below to install the hard disk:

1. Loosen all screws

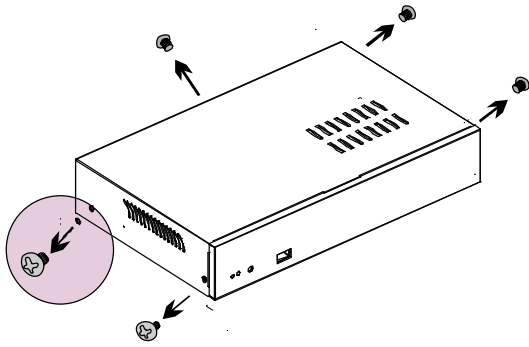

2. Push the cover backward and lift

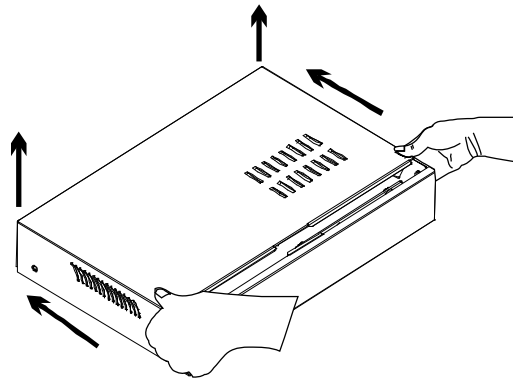

3. Secure the brackets on the hard disk

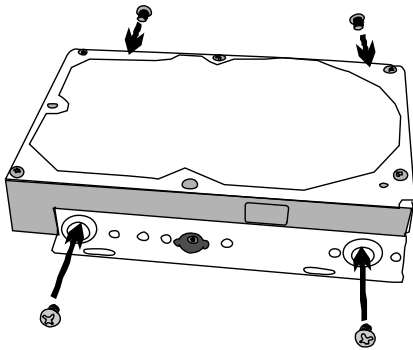

4. Connect the end of the IDE cable and the power connector to the hard disk

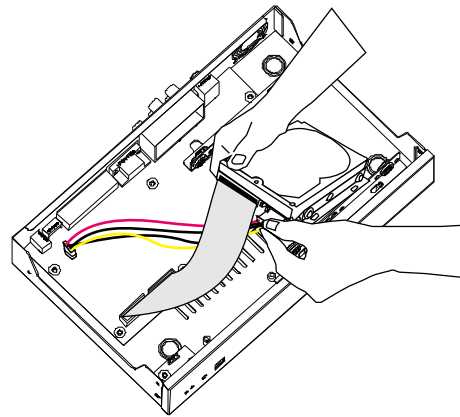

5. Secure the hard disk inside the unit then replace unit cover

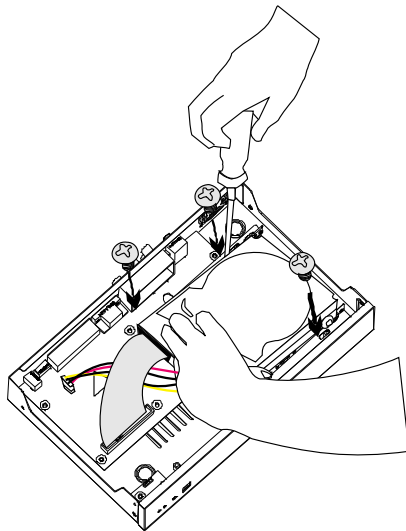

6. Push the cover forward

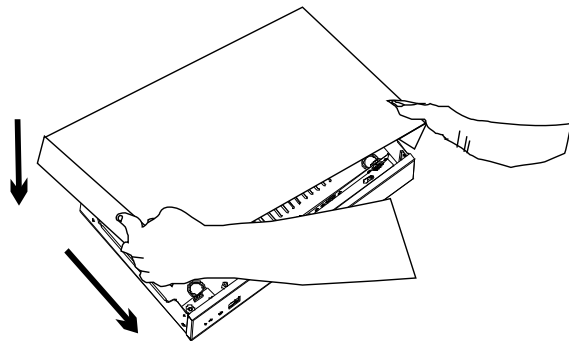

7. Secure the cover

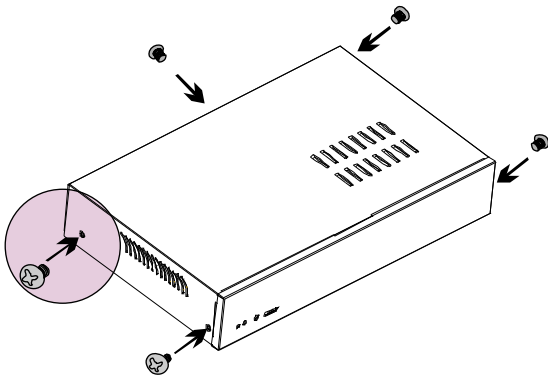

8. You may now connect all the cables. When the power is connected, the Power LED light  turns on

1.5.2 Connecting Devices

The back panel of the DVR unit, user can connect up to 4 video cameras, 4 sensor devices, 1 alarm device and output video to a TV or CRT/LCD monitor. Connecting the unit to a pen drive or external hard disk through USB connection for backup, then use the bundled software enables user to transfer, playback and segment the video. Follow the illustration below to make the connection:

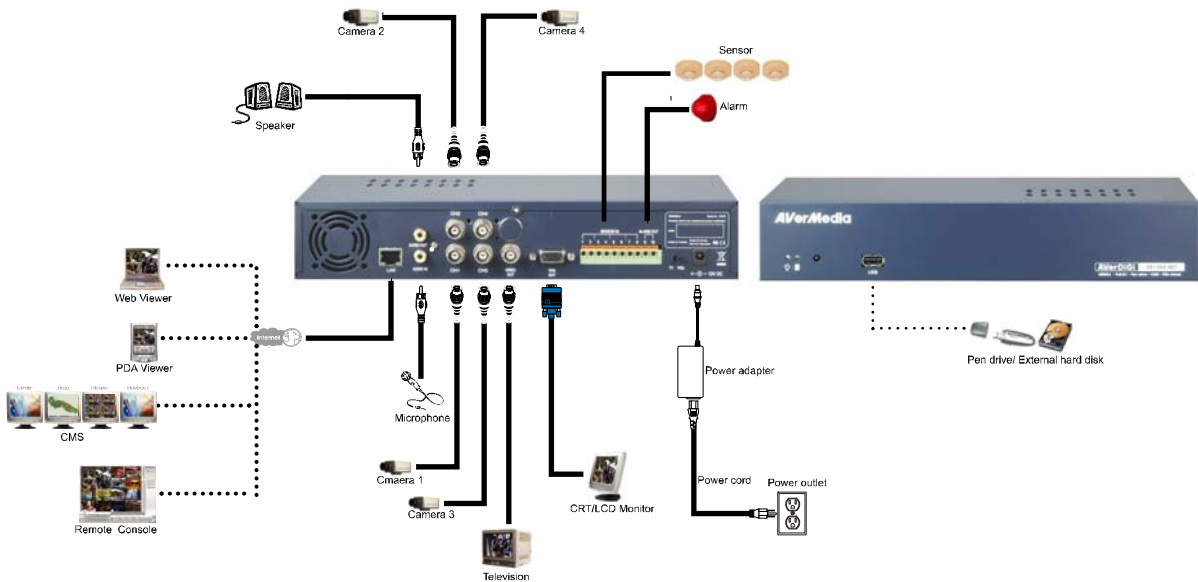

Each time you change the video display output, the power must be turned **off** and **on** to reset the DVR unit.

1.5.3 Connecting the Sensor/Relay device

The Sensor and Alarm ports enable you to connect (4) sensor inputs and (1) relay outputs. Just connect the external sensor and relay pin directly to the pinhole. Check the table below and locate which pinhole is assigned to sensor input and relay output.

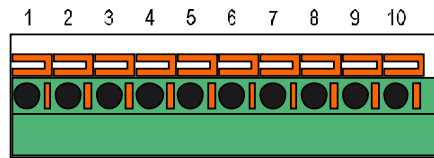

1.5.3.1 I/O Card Sensor and Relay pinhole allocation:

The signal from the sensor (i.e., infrared sensors, smoke detectors, proximity sensors, door sensors, etc.) is being transmitted to the unit and this triggers the system to respond and send signal to relay device (i.e., alarm, telephone etc).

Pin #	Definition
1	Sensor 1 Ground signal
2	Sensor 1 signal
3	Sensor 2 Ground signal
4	Sensor 2 signal
5	Sensor 3 Ground signal
6	Sensor 3 signal
7	Sensor 4 Ground signal
8	Sensor 4 signal
9	Relay signal
10	Relay signal

Chapter 2 Operating the EB1304 NET



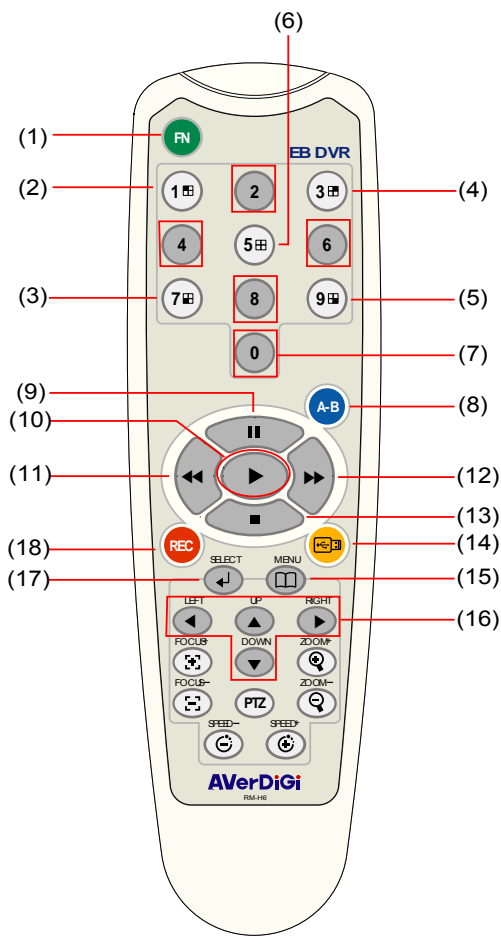

2.1 Familiarizing the Remote Control Buttons

Use the Remote control to operate the OSD menu on surveillance screen.



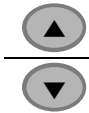





Button	Function
(1)	A functional key for multiple DVR system remote control
(2)	Switch to Channel 1 As a number key for entering password
(3)	Switch to Channel 2 As a number key for entering password
(4)	Switch to Channel 3 As a number key for entering password
(5)	Switch to Channel 4 As a number key for entering password
(6)	Switch to CIF mode As a number key for entering password
	As a number key for entering password

Button	Function
(8)	Set a playing recorded video from A point to B point segment and repeat playing on surveillance screen(See 2.1.1)
(9)	Pause the playing
(10)	To play the video
(11)	Decrease the video playback at the speed of 2x, 4x 8x or 16x
(12)	Fast play the video playback at the speed of 2x, 4x 8x or 16x
(13)	Stop playing / Stop recording
(14)	USB backup(see 2.1.2)
(15)	To move the selection to the left and right





Button	Function
(15) 	To go up and down and select the items in the menu list or change the settings
(16) 	To enter the OSD Main menu / Exit from the main menu or sub-menu display
(17) 	Make a selection Enter sub-menu
(18) 	Start video recording

 The buttons which list below are not functional for the EB1304 NET.

2.1.1 Using AB Repeat Function



AB Repeat function allow user to set a video segment from A to B point and play on the surveillance screen until user stop. User also can backup AB Repeat file to pen drive or external hard disk (See [2.1.2](#)).

1. Press  (play button) to call out the **SEARCH MODE** menu to find the recorded video that user wants to playback.
2. Select **TIME SEARCH** or **EVENT LIST**.
 - **TIME SEARCH** (search by date and time): select the date and time from where you want to begin the video playback.
 - **EVENT LIST** (search by condition): select from the list.
3. During the playback, press  to set the A point of video segment. And then, press  again to set the B point of video segment. On the surveillance screen will display "A-B" and repeat playing the AB point video segment which user has set. To cancel AB repeat, press  again.



2.1.2 Using USB Backup Button

User can press  button to backup the AB Repeat video file.

1. Set the AB Repeat file (see [2.1.1](#)).
2. Plug in pen drive or external hard disk to DVR system.
3. During the AB Repeat playback, press  button.
4. And then, press  (YES) to start backup file or press  (NO) to exit backup mode.

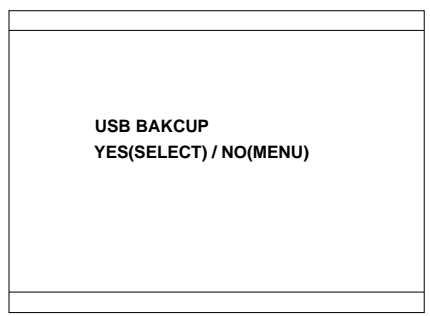



- If the external hard disk is first time using, please format to FAT32 format.
- The external hard disk needs to be powered by external power.

2.2 Using the EB1304 NET for the First Time

Upon connecting the power, the unit automatically detects the status of the hard disk. The hard disk must be formatted before user can use it with EB1304 NET. If you are prompt to format the hard disk, press (select) for **YES** to format the hard disk and (menu) for **NO** to remain unchanged.

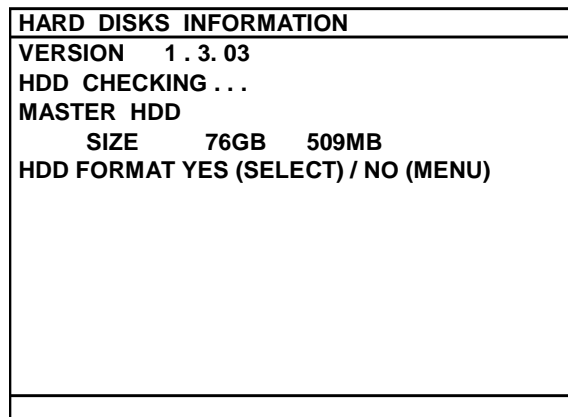



2.2.1 Set up the System Date and Time

Before starting record video, adjust the date and time first.

1. Press to call up the OSD menu and then use and to go up and down and select Submenu. And then, press to confirm the selection.
2. In Submenu, select the Date and press again to make a selection. And then, use and to adjust the date and use and buttons to move the selection to the left and right.
3. To adjust Time, follow the above step 2 and 3.
4. Press to go back to main menu after adjustment.

2.3 Surveillance Screen

To know if the channel is being recorded, the “●” record symbol would appear beside the channel number. The  (microphone) and  (speaker) indicate that the audio is available. The information below the screen shows the current date and time, recording mode (record schedule setting), and the percentage of the used hard disk space.

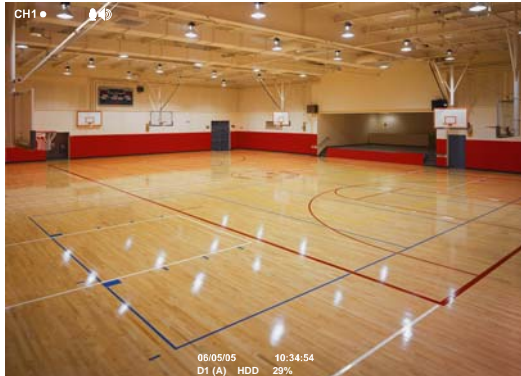

D1 mode Screen Preview

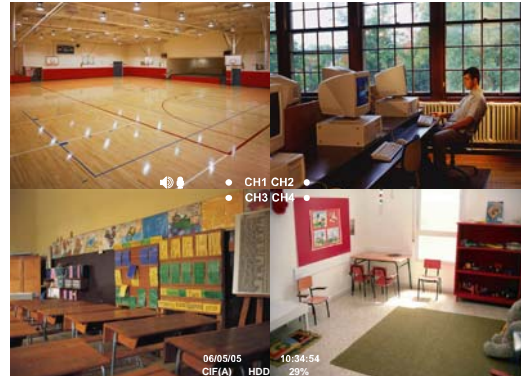

CIF model Preview

When you are in full screen preview, press the following buttons on the remote control to switch to different channel, or preview all 4 channels:



CH1: Camera1



CH2: Camera 2



CH3: Camera 3







CH4: Camera 4



QUAD: 4-Channel



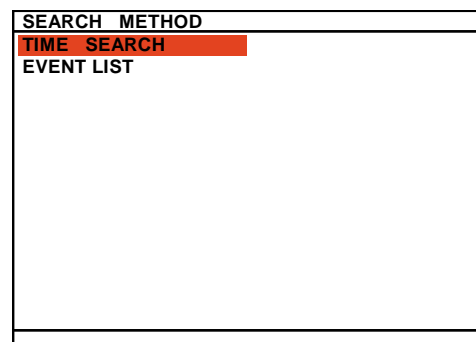

2.4 Playback the Video

The DVR system can record and playback video simultaneously. Therefore, user don't need to stop recording while playback the video.







1. Press 
2. Use the  and  buttons to go up and down and select TIME SEARCH or EVENT LIST. Then, press  or  to make a selection.

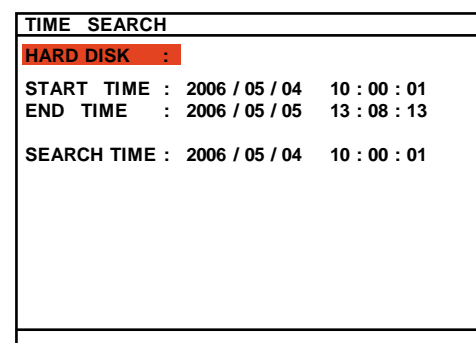





TIME SEARCH (search by date and time):







1. Use the  and  buttons and select **SEARCH TIME**. Then press  or  again to make the selection.
2. In the **SEARCH TIME**, user may now select the date and time from where you want to begin the video playback.



Use the  and  buttons to move the selection to the left and right. Use the  and  buttons to select the date and time. Then press  or  again to make the selection.

3. To start video playback, the time in second must be set. Use the  buttons to move the selection to the right most. Use the  and  buttons and select the time in second. Then press  or .

EVENT LIST (search by event):

1. Use the  and  buttons to select from the list. Press  or  again to make the selection. User  and  to go next page or back to previous page.
2. Listed below are the following recording conditions:

EVENT LIST			
S	2006 / 05 / 03	13 : 26 : 34	13 : 26 : 50
A	2006 / 05 / 03	13 : 00 : 01	13 : 16 : 46
A	2006 / 05 / 03	12 : 00 : 01	13 : 00 : 01
B	2006 / 05 / 03	11 : 48 : 37	12 : 00 : 00
A	2006 / 05 / 03	11 : 30 : 23	11 : 31 : 18
A	2006 / 05 / 03	11 : 29 : 47	11 : 30 : 13
B	2006 / 05 / 03	11 : 28 : 55	11 : 28 : 58
S	2006 / 05 / 03	11 : 28 : 33	11 : 28 : 55
A	2006 / 05 / 03	11 : 25 : 41	11 : 28 : 32
A	2006 / 05 / 03	11 : 23 : 26	11 : 23 : 30
▼			

A – Always Recording

It records non-stop and automatically continue recording when interrupted

S – Sensor Recording

It records when the sensor has triggered

M – Motion Recording

It records when any movement has detected

B – Button Recording

It records when the  record button is pressed

3. The “▶” play symbol would appear beside the channel number when you are previewing in playback mode.

Chapter 3 OSD Navigation Tree

The follow figure is an OSD menu tree map. To call out the OSD menu, press  on the remote control.

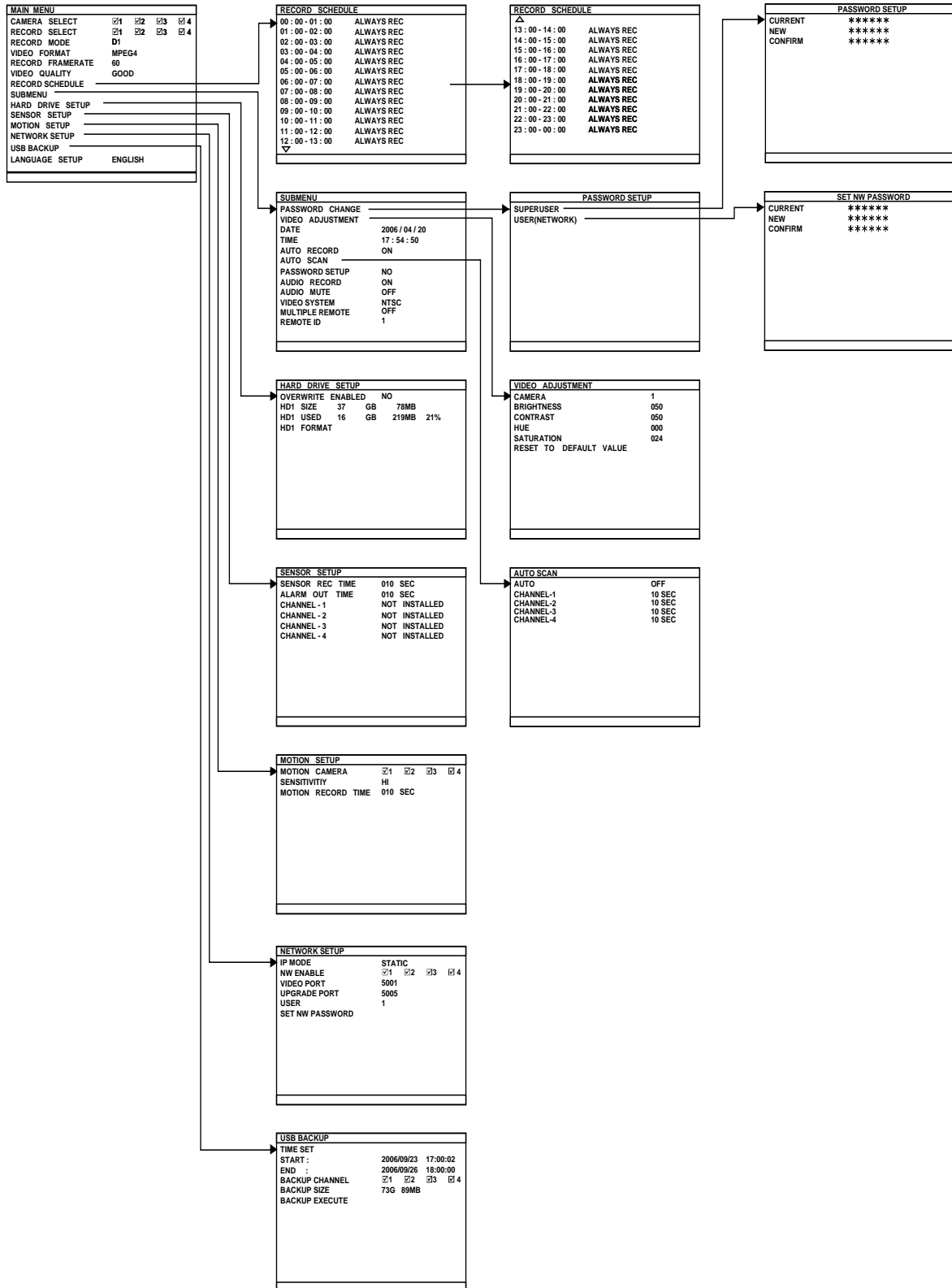

3.1 Menu Function

If the unit is currently recording the video, user may have to stop video recording to change the settings. Use remote control to navigate in the OSD menu. The red frame turns yellow when you are making a selection.

OSD MENU	Description																																							
<table border="1"> <thead> <tr> <th colspan="2">MAIN MENU</th> </tr> </thead> <tbody> <tr> <td>CAMERA SELECT</td> <td><input checked="" type="checkbox"/>1 <input checked="" type="checkbox"/>2 <input checked="" type="checkbox"/>3 <input checked="" type="checkbox"/>4</td> </tr> <tr> <td>RECORD SELECT</td> <td><input checked="" type="checkbox"/>1 <input checked="" type="checkbox"/>2 <input checked="" type="checkbox"/>3 <input checked="" type="checkbox"/>4</td> </tr> <tr> <td>RECORD MODE</td> <td>D1</td> </tr> <tr> <td>VIDEO FORMAT</td> <td>MPEG4</td> </tr> <tr> <td>RECORD FRAMERATE</td> <td>60</td> </tr> <tr> <td>VIDEO QUALITY</td> <td>GOOD</td> </tr> <tr> <td>RECORD SCHEDULE</td> <td></td> </tr> <tr> <td>SUBMENU</td> <td></td> </tr> <tr> <td>HARD DRIVE SETUP</td> <td></td> </tr> <tr> <td>SENSOR SETUP</td> <td></td> </tr> <tr> <td>MOTION SETUP</td> <td></td> </tr> <tr> <td>NETWORK SETUP</td> <td></td> </tr> <tr> <td>USB BACKUP</td> <td></td> </tr> <tr> <td>LANGUAGE SETUP</td> <td>ENGLISH</td> </tr> </tbody> </table>	MAIN MENU		CAMERA SELECT	<input checked="" type="checkbox"/> 1 <input checked="" type="checkbox"/> 2 <input checked="" type="checkbox"/> 3 <input checked="" type="checkbox"/> 4	RECORD SELECT	<input checked="" type="checkbox"/> 1 <input checked="" type="checkbox"/> 2 <input checked="" type="checkbox"/> 3 <input checked="" type="checkbox"/> 4	RECORD MODE	D1	VIDEO FORMAT	MPEG4	RECORD FRAMERATE	60	VIDEO QUALITY	GOOD	RECORD SCHEDULE		SUBMENU		HARD DRIVE SETUP		SENSOR SETUP		MOTION SETUP		NETWORK SETUP		USB BACKUP		LANGUAGE SETUP	ENGLISH	<p>CAMERA SELECT : Enable/disable the channel number to display the video on the surveillance screen</p> <p>RECORD SELECT : Enable/disable the channel number to record video</p> <hr/> <p> The channels which could be recorded should be enabled in the CAMERA SELECT first.</p> <hr/> <p>RECORD MODE : Select D1/CIF recording mode</p> <p>Under D1 mode, the video recording is in full screen resolution and takes turns from one channel to the next one when Auto Scan enables. Each channel is recorded only at a maximum frame rate of 15fps. User can switch to view the video in single full screen or QUAD screen</p> <p>Whereas in CIF mode, video recording is at a lower resolution, but each video is recorded in 30fps/25fps (NTSC/PAL). User can switch to view the video in single full screen or QUAD screen</p> <p>VIDEO FORMAT : The recorded video is in MPEG4 format</p> <p>RECORD FRAME RATE : Set the number of frames per second to be recorded. Refer to the table below for the available record frame rate settings. The higher the frame rate is, it uses more hard disk space</p> <table border="1"> <thead> <tr> <th>Video Standard \ Record Mode</th> <th>NTSC</th> <th>PAL</th> </tr> </thead> <tbody> <tr> <td>D1</td> <td>60, 20, 4</td> <td>48, 20, 4</td> </tr> <tr> <td>CIF</td> <td>120, 60, 40, 20, 4</td> <td>100, 48, 20, 4</td> </tr> </tbody> </table> <p>VIDEO QUALITY : Select the video quality setting from BEST, HIGH, MEDIUM, GOOD, NORMAL or LOW.</p> <p>BEST – best record quality but less record hours</p> <p>LOW – longest record hour but quality is ordinary</p> <p>NORMAL – allows you to record more hours but the quality of the recorded video is moderate.</p> <p>LANGUAGE SETUP : Select from the available languages</p>	Video Standard \ Record Mode	NTSC	PAL	D1	60, 20, 4	48, 20, 4	CIF	120, 60, 40, 20, 4	100, 48, 20, 4
MAIN MENU																																								
CAMERA SELECT	<input checked="" type="checkbox"/> 1 <input checked="" type="checkbox"/> 2 <input checked="" type="checkbox"/> 3 <input checked="" type="checkbox"/> 4																																							
RECORD SELECT	<input checked="" type="checkbox"/> 1 <input checked="" type="checkbox"/> 2 <input checked="" type="checkbox"/> 3 <input checked="" type="checkbox"/> 4																																							
RECORD MODE	D1																																							
VIDEO FORMAT	MPEG4																																							
RECORD FRAMERATE	60																																							
VIDEO QUALITY	GOOD																																							
RECORD SCHEDULE																																								
SUBMENU																																								
HARD DRIVE SETUP																																								
SENSOR SETUP																																								
MOTION SETUP																																								
NETWORK SETUP																																								
USB BACKUP																																								
LANGUAGE SETUP	ENGLISH																																							
Video Standard \ Record Mode	NTSC	PAL																																						
D1	60, 20, 4	48, 20, 4																																						
CIF	120, 60, 40, 20, 4	100, 48, 20, 4																																						

OSD MENU	Description
----------	-------------

RECORD SCHEDULE	
00 : 00 - 01 : 00	ALWAYS REC
01 : 00 - 02 : 00	ALWAYS REC
02 : 00 - 03 : 00	ALWAYS REC
03 : 00 - 04 : 00	ALWAYS REC
04 : 00 - 05 : 00	ALWAYS REC
05 : 00 - 06 : 00	ALWAYS REC
06 : 00 - 07 : 00	ALWAYS REC
07 : 00 - 08 : 00	ALWAYS REC
08 : 00 - 09 : 00	ALWAYS REC
09 : 00 - 10 : 00	ALWAYS REC
10 : 00 - 11 : 00	ALWAYS REC
11 : 00 - 12 : 00	ALWAYS REC
12 : 00 - 13 : 00	ALWAYS REC
▼	

RECORD SCHEDULE:

By default, in 24 hours, the recording schedule is set to always record every hour. Refer to the table below to customize the recording condition

Condition	Description
NO REC	Disable video recording
ALWAYS REC	Record non-stop
MOTION REC	Start recording when any movement is detected
SENSOR REC	Start recording when the sensor has triggered
BUTTON REC	Start recording when the record button is pressed

SUBMENU	
PASSWORD CHANGE	
VIDEO ADJUSTMENT	
DATE	2006 / 04 / 20
TIME	17 : 54 : 50
AUTO RECORD	ON
AUTO SCAN	ON
PASSWORD SETUP	NO
AUDIO RECORD	ON
AUDIO MUTE	OFF
VIDEO SYSTEM	NTSC
MUTIPLE REMOTE	OFF
REMOTE ID	1

PASSWORD CHANGE :

Set a security combination number. There are two type of user password – SUPERUSER and USER.

PASSWORD CHANG	
SUPERUSER	
USER(NETWORK)	

Use the number button on the remote control to enter the password. Or use ▲ and ▼ button to the select the security combination number. Press ↵ or ► button to confirm.

SUPERUSER:

Superuser has the authority of formatting hard disk, changing system settings, remote monitor the DVR system and changes the system settings. The factory default password is 111111.

PASSWORD SETUP	
CURRENT	*****
NEW	*****
CONFIRM	*****

OSD MENU	Description																																		
<table border="1"> <tr><td colspan="2">SUBMENU</td></tr> <tr><td colspan="2">PASSWORD CHANGE</td></tr> <tr><td>VIDEO ADJUSTMENT</td><td></td></tr> <tr><td>DATE</td><td>2006 / 04 / 20</td></tr> <tr><td>TIME</td><td>17 : 54 : 50</td></tr> <tr><td>AUTO RECORD</td><td>ON</td></tr> <tr><td>AUTO SCAN</td><td>ON</td></tr> <tr><td>PASSWORD SETUP</td><td>NO</td></tr> <tr><td>AUDIO RECORD</td><td>ON</td></tr> <tr><td>AUDIO MUTE</td><td>OFF</td></tr> <tr><td>VIDEO SYSTEM</td><td>NTSC</td></tr> <tr><td>MUTIPLE REMOTE</td><td>OFF</td></tr> <tr><td>REMOTE ID</td><td>1</td></tr> </table>	SUBMENU		PASSWORD CHANGE		VIDEO ADJUSTMENT		DATE	2006 / 04 / 20	TIME	17 : 54 : 50	AUTO RECORD	ON	AUTO SCAN	ON	PASSWORD SETUP	NO	AUDIO RECORD	ON	AUDIO MUTE	OFF	VIDEO SYSTEM	NTSC	MUTIPLE REMOTE	OFF	REMOTE ID	1	<p>USER(NETWORK):</p> <p>The login account for remote connection through the internet. User account only can view and playback recorded video by Web viewer (ex: Internet Explorer), but no authority to change the DVR system's setting. The factory default password is 111111.</p> <table border="1"> <tr><td colspan="2">SET NW PASSWORD</td></tr> <tr><td>CURRENT</td><td>*****</td></tr> <tr><td>NEW</td><td>*****</td></tr> <tr><td>CONFIRM</td><td>*****</td></tr> </table>	SET NW PASSWORD		CURRENT	*****	NEW	*****	CONFIRM	*****
SUBMENU																																			
PASSWORD CHANGE																																			
VIDEO ADJUSTMENT																																			
DATE	2006 / 04 / 20																																		
TIME	17 : 54 : 50																																		
AUTO RECORD	ON																																		
AUTO SCAN	ON																																		
PASSWORD SETUP	NO																																		
AUDIO RECORD	ON																																		
AUDIO MUTE	OFF																																		
VIDEO SYSTEM	NTSC																																		
MUTIPLE REMOTE	OFF																																		
REMOTE ID	1																																		
SET NW PASSWORD																																			
CURRENT	*****																																		
NEW	*****																																		
CONFIRM	*****																																		

<table border="1"> <tr><td colspan="2">SUBMENU</td></tr> <tr><td colspan="2">PASSWORD CHANGE</td></tr> <tr><td colspan="2">VIDEO ADJUSTMENT</td></tr> <tr><td>DATE</td><td>2006 / 04 / 20</td></tr> <tr><td>TIME</td><td>17 : 54 : 50</td></tr> <tr><td>AUTO RECORD</td><td>ON</td></tr> <tr><td>AUTO SCAN</td><td>ON</td></tr> <tr><td>PASSWORD SETUP</td><td>NO</td></tr> <tr><td>AUDIO RECORD</td><td>ON</td></tr> <tr><td>AUDIO MUTE</td><td>OFF</td></tr> <tr><td>VIDEO SYSTEM</td><td>NTSC</td></tr> <tr><td>MUTIPLE REMOTE</td><td>OFF</td></tr> <tr><td>REMOTE ID</td><td>1</td></tr> </table>	SUBMENU		PASSWORD CHANGE		VIDEO ADJUSTMENT		DATE	2006 / 04 / 20	TIME	17 : 54 : 50	AUTO RECORD	ON	AUTO SCAN	ON	PASSWORD SETUP	NO	AUDIO RECORD	ON	AUDIO MUTE	OFF	VIDEO SYSTEM	NTSC	MUTIPLE REMOTE	OFF	REMOTE ID	1	<p>VIDEO ADJUSTMENT :</p> <p>Select the camera number and set to adjust the video brightness, contrast, hue, and saturation value</p> <table border="1"> <tr><td colspan="2">VIDEO ADJUSTMENT</td></tr> <tr><td>CAMERA</td><td>1</td></tr> <tr><td>BRIGHTNESS</td><td>050</td></tr> <tr><td>CONTRAST</td><td>050</td></tr> <tr><td>HUE</td><td>000</td></tr> <tr><td>SATURATION</td><td>024</td></tr> <tr><td>RESET TO DEFAULT VALUE</td><td>NO</td></tr> </table>	VIDEO ADJUSTMENT		CAMERA	1	BRIGHTNESS	050	CONTRAST	050	HUE	000	SATURATION	024	RESET TO DEFAULT VALUE	NO
SUBMENU																																									
PASSWORD CHANGE																																									
VIDEO ADJUSTMENT																																									
DATE	2006 / 04 / 20																																								
TIME	17 : 54 : 50																																								
AUTO RECORD	ON																																								
AUTO SCAN	ON																																								
PASSWORD SETUP	NO																																								
AUDIO RECORD	ON																																								
AUDIO MUTE	OFF																																								
VIDEO SYSTEM	NTSC																																								
MUTIPLE REMOTE	OFF																																								
REMOTE ID	1																																								
VIDEO ADJUSTMENT																																									
CAMERA	1																																								
BRIGHTNESS	050																																								
CONTRAST	050																																								
HUE	000																																								
SATURATION	024																																								
RESET TO DEFAULT VALUE	NO																																								

DATE :

Set the current date

TIME :

Set the current time

AUTO RECORD :

Enable/disable auto continue recording when interrupted (i.e., power breakdown, video playback or configuration setup). It continue recording after 10 second of idleness. This is applicable in Always Record mode

AUTO SCAN :

Enable/disable auto cycle switch to display the next channel when in full screen preview. User can set different switch time for each channel. The time range is from 5 ~30 seconds.

AUTO SCAN	
AUTO SCAN	OFF
CHANNEL - 1	10 SEC
CHANNEL - 2	10 SEC
CHANNEL - 3	10 SEC
CHANNEL - 4	10 SEC

OSD MENU	Description
----------	-------------

SUBMENU	
PASSWORD CHANGE	
VIDEO ADJUSTMENT	
DATE	2006 / 04 / 20
TIME	17 : 54 : 50
AUTO RECORD	ON
AUTO SCAN	ON
PASSWORD SETUP	NO
AUDIO RECORD	ON
AUDIO MUTE	OFF
VIDEO SYSTEM	NTSC
MUTIPLE REMOTE	OFF
REMOTE ID	1

PASSWORD SETUP :

Enable/disable full system password protection. This would prevent unauthorized user to stop video recording, change system settings and formatting the hard disk

AUDIO RECORD :

Enable/disable audio recording. To record sound, make sure the audio input device(ex: microphone) is connected to the unit

AUDIO MUTE :

Enable/disable to hear audio sound. To hear sound, make sure the unit is connected to an audio output device (ex: speaker). If user recorded video in audio mute status, there is no sound when playback



The audio input and output device need to be powered by external power.

VIDEO SYSTEM:

DVR system will auto detect the video system and display

SUBMENU	
PASSWORD CHANGE	
VIDEO ADJUSTMENT	
DATE	2006 / 04 / 20
TIME	17 : 54 : 50
AUTO RECORD	ON
AUTO SCAN	ON
PASSWORD SETUP	NO
AUDIO RECORD	ON
AUDIO MUTE	OFF
VIDEO SYSTEM	NTSC
MUTIPLE REMOTE	OFF
REMOTE ID	1

MUTIPLE REMOTE:

Enable/disable multiple DVR system remote control. When user has more than one DVR system, user can use **MULTIPLE REMOTE** function to control all DVR system by single remote control.

REMOTE ID:

Assign the ID number for multiple DVR system remote controls. When there are more than one DVR systems, user can enable **MULTIPLE REMOTE** function, and then assign **REMOTE ID** to each DVR system. Then, user can just use one remote control to control all DVR system by pressing **REMOTE ID**. To remote control multiple DVR systems, press  and number key (remote ID number) on the remote control.

HARD DRIVE SETUP				
OVERWRITE ENABLED	YES			
HDD SIZE	37	GB	78MB	
HDD USED	0	GB	232MB	0%
HDD FORMAT				

- * HDD SIZE shows the total capacity of the hard disk.
- * HDD USED shows the amount of space that has been used.













OVERWRITE ENABLED :

Enable/disable overwriting the earliest record when the hard disk space runs out. By default, the HDD overwrite setting is enabled

HDD FORMAT :

For security purpose, you may have to enter the password to format hard disk

To format hard disk:

1. Use the  and  buttons to go up and down and select **HDD FORMAT**. Then press  or .
2. In the **CHECK PASSWORD** screen, press  or . Then use the  and  buttons to select the security combination number. Repeat till you key in the last number. Also, user can use the number button on the remote control to enter the password. Press  or  button again to make the selection. To move the selection to the left and right, use  and  buttons

CHECK PASSWORD	
ENTER PASSWORD	*****

3. After entering the last number, the system will format the hard disk
4. It is done when the **"HDD FORMAT COMPLETED"** appears

HARD DRIVE SETUP				
OVERWRITE ENABLED	YES			
HDD SIZE	37	GB	78MB	
HDD USED	0	GB	232MB	0%
HDD FORMAT				
HDD FORMAT COMPLETE				



Formatting the hard disk will permanently delete all the records and can no longer be retrieved

OSD MENU	Description
----------	-------------

SENSOR SETUP	
SENSOR REC TIME	010 SEC
ALARM OUT TIME	010 SEC
CHANNEL - 1	NOT INSTALLED
CHANNEL - 2	NOT INSTALLED
CHANNEL - 3	NOT INSTALLED
CHANNEL - 4	NOT INSTALLED

SENSOR REC TIME :

Set the amount of time (in second) to start record when the sensor has triggered

ALARM OUT TIME :

Set the amount of time (in second) to continue sending the alarm once triggered

CHANNEL 1~4 :

Customize the initial state of the attached sensor. Refer to the table below to customize the sensor state

Condition	Description
NOT INSTALLED	Indicates that there is no sensor connected
NORMAL OPEN	Indicates that the initial state of the sensor is normal open. Video recording initiates when there is a changes in the sensor state
NORMAL CLOSE	Indicates that the initial state of the sensor is normal close. Video recording initiates when there is a changes in the sensor state

MOTION SETUP	
MOTION CAMERA	<input checked="" type="checkbox"/> 1 <input checked="" type="checkbox"/> 2 <input checked="" type="checkbox"/> 3 <input checked="" type="checkbox"/> 4
SENSITIVITY	L
MOTION RECORD TIME	010 SEC

MOTION CAMERA :

Enable/disable the channel number to detect motion.

SENSITIVITY :

Set the sensitivity level. The sensitivity is from H (High), 9~ 2 and L (Low).

MOTION RECORD TIME :

Set the amount of time (in second) to record when motion is detected.







NETWORK SETUP	
IP MODE	STATIC
NW ENABLE	<input checked="" type="checkbox"/> 1 <input checked="" type="checkbox"/> 2 <input checked="" type="checkbox"/> 3 <input checked="" type="checkbox"/> 4
VIDEO PORT	80
UPGARDE PORT	5005







NETWORK SETUP:

Setup the network parameters for the internet or intranet remote monitor or playback.

IP MODE:

The system provides 3 types of IP setup mode – Static, DHCP, and PPPOE.

Use  and  buttons to go up and down and select **IP MODE**, and then press . Use  and  buttons to change the selections and press  or  to make a selection.





- **STATIC:** Assigns a constant IP address for the DVR system. Use  and  buttons to go up and down and select items, and then press  or  to make selection. Use  and  to move left and right to select or enter the configuration value.
 - **IP ADDRESS:** Assign a constant IP address which a real IP addresses give from ISP to DVR system.
 - **SUBNET:** It is a bitmask used to identify the sub network and how many bits provide room for host addresses. Enter the subnet mask of the IP address which user has assigned to DVR system.

OSD MENU**Description**

NETWORK SETUP	
IP MODE	STATIC
NW ENABLE	<input checked="" type="checkbox"/> 1 <input checked="" type="checkbox"/> 2 <input checked="" type="checkbox"/> 3 <input checked="" type="checkbox"/> 4
VIDEO PORT	80
UPGARDE PORT	5005

- **GATEWAY:** A network device act as a passageway to internet. Enter the network gateway IP address
- **DNS:** Domain Name Server translates domain names (such as www.abb.com.tw) to IP addresses. Enter the IP address of DNS if it is available.
- **MAC ADDRESS:** Only for user information. Don't need to enter the MAC address.
- When all parameters are set, select the **CHANGE** to confirm the configuration.

NETWORK INFORMATION	
IP ADDRESS	192.168.153.100
SUB NET	255.255.255.255
GATEWAY	192.168.153.254
DNS	192.168.153.1
MAC ADDRESS	00.00.00.00.00.00
CHANGE	

- **DHCP:** Assign the IP address by local DHCP server to DVR system. Use  and  buttons to go up and down and select **DHCP**, and then press  or  to make selection.



The DHCP (Dynamic Host Configuration Protocol) is a set of rules used by a communications device (such as a computer, router or networking adaptor) to allow the device to request and get an Internet address from a server which has a list of addresses available for assignment

The DVR system will try to get an IP address from the DHCP server. A message window will show up as below:







When DVR system gets an IP address from DHCP server, the information will display as below:

NETWORK INFORMATION	
IP ADDRESS	192.168.153.100
SUB NET	255.255.255.255
GATEWAY	192.168.153.254
DNS	192.168.153.1
MAC ADDRESS	00.00.00.00.00.00
CHANGE	

- **PPPOE:** Point-to-Point Protocol over Ethernet is a network protocol for encapsulating PPP frames in Ethernet frames. It is used mainly with ADSL services. If your network is using ADSL service connecting to internet, and then, select

OSD MENU	Description
----------	-------------

NETWORK SETUP	
IP MODE	STATIC
NW ENABLE	<input checked="" type="checkbox"/> 1 <input checked="" type="checkbox"/> 2 <input checked="" type="checkbox"/> 3 <input checked="" type="checkbox"/> 4
VIDEO PORT	80
UPGARDE PORT	5005

PPPOE mode. Use  and  buttons to go up and down and select **PPPOE**, and then press  or  to make selection. A message window will show up as below:













When DVR system get an IP address, the information will display as below:

NETWORK INFORMATION	
IP ADDRESS	000.000.000.000
SUB NET	000.000.000.000
GATEWAY	192.168.153.254
DNS	192.095.000.001
MAC ADDRESS	00.00.00.00.00.00
CHANGE	

NW ENABLE:











Allow internet remote user to playback or monitor the channels. Without enabling the network function, the channels cannot be playback or monitor from remote site.

-  1 is Channel 1 2 is Channel 2
 3 is Channel 3 4 is Channel 4

Use  and  buttons to go up and down and select **NW ENABLE** (network enable), and then press  or  and  or  to move to the selection. Use  and  buttons to change the selections values and press  or  to confirm.

VIDEO PORT:

A port for the remote connection. Any port can be assigned as a video port, except the ports already used by the network services. The default video port is 80.

Use  and  buttons to go up and down and select **VIDEO PORT**, and then press  or  and  or  to move to the selection. Use  and  buttons to change the selections values and press  or  to confirm.

UPGRADE PORT:

A port for the remote update DVR system firmware. Any port can be assigned as an upgrade port, except the ports are already used by the network services. The default upgrade port is 5005. For Upgrading DVR firmware, please contact your local dealer.

OSD MENU

Description

NETWORK SETUP

IP MODE	PPPOE
NW ENABLE	<input checked="" type="checkbox"/> 1 <input checked="" type="checkbox"/> 2 <input checked="" type="checkbox"/> 3 <input checked="" type="checkbox"/> 4
VIDEO PORT	80
UPGARDE PORT	5005



Please **DO NOT** cut off the power of the DVR system while the firmware is upgrading. Power failure will cause the permanent damage of the DVR system.

Use and buttons to go up and down and select **UPGRADE PORT**, and then press or and to move to the selection. Use and buttons to change the selections values and press or to confirm.

USB BAKCUP

TIME SET

START TIME	: 2006 / 05 / 04	10 : 00 : 01
END TIME	: 2006 / 05 / 05	13 : 08 : 13

BACKUP CHANNEL	<input checked="" type="checkbox"/> 1 <input checked="" type="checkbox"/> 2 <input checked="" type="checkbox"/> 3 <input checked="" type="checkbox"/> 4
BACKUP SIZE	73GB 89MB
BACKUP EXECUTE	

USB BACKUP:

Using USB device (ex. Pen drive or External Hard disk) to backup partial recorded video and playback on PC.

Use and buttons to go up and down and select **USB BACKUP**, and then press or . Use and to move left and right. And, use and buttons to change the value and press or to confirm.



- Remember to plug in the USB device before starting to backup.
- If the external hard disk is first time using, please format to FAT32 format.
- The DVR system supports external hard disk capacity up to 32GB.
- The external hard disk needs to be power by external power.

1. Select the **START TIME** and **END TIME**.
2. Select the channels which user wants to backup.
3. The DVR system will display the system hard disk space and backup file size.
4. And then, select **BACKUP EXECUTE** to start backup video to the USB device.
5. When backup is done, press any key to back to main menu.
6. To view the backup file, using USB Playback Application(see [4.3](#))

Chapter 4 Using the USB Playback Console

4.1 Recommended system requirements

- Pentium®4 2.4GHZ or above
- Windows®2000/ XP
- DDR 256 MB
- Graphic function must support DirectDraw
- Audio card or built-in
- Speaker
- 1 available USB2.0 port

4.2 Installing the USB Playback Console

To install the USB Playback Console:

1. Place Installation CD into the CD-ROM drive. When the installation main screen appears, click **Install USB Playback Console** and then follow the on screen instructions



2. Select the language you prefer



3. Click **OK** to install the application
4. Click **Exit** to close the installation main screen. You may plug in the pen drive or external hard disk now.

4.3 Running the USB Playback Console

To run the application, click the  icon on the PC desktop

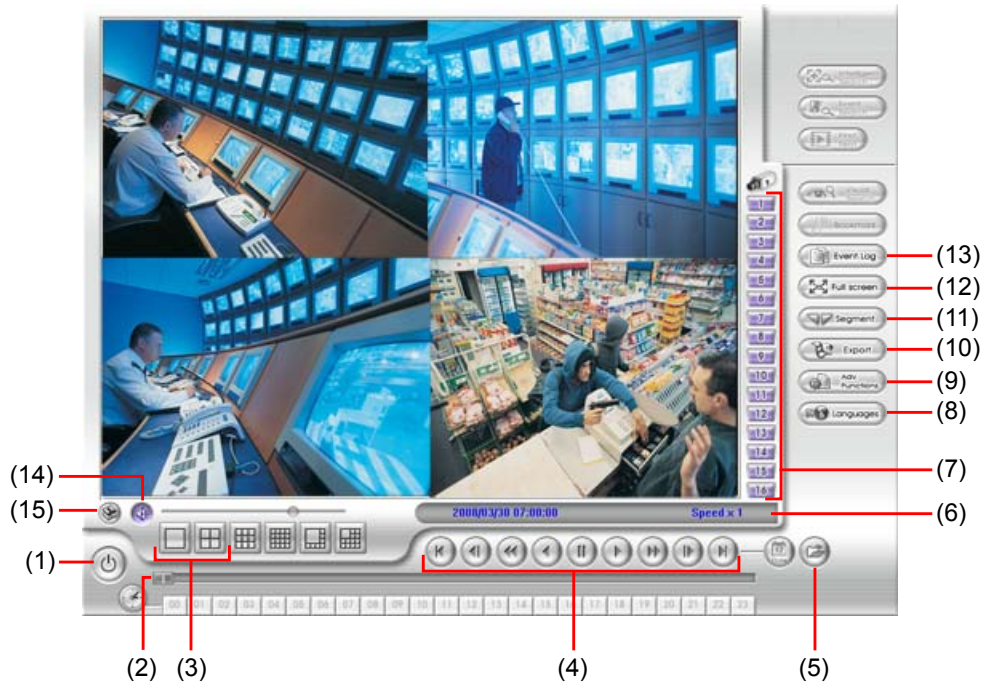

Name	Function
(1) Exit	Exit/ Minimize the application or chose Cancel to go back to the application. About: shows DVR application version information.
(2) Progress bar	Show the progress of the file being played. You may move the bar to seek at any location of the track.
(3) Split Screen Mode	Select from different screen view to playback the recorded video file of the entire camera or one camera on screen.
(4) Playback Controller	Begin: Move at the beginning of the recorded video file. Previous: Go back to the previous frame by frame. Slower: Play the recorded video file at the speed of 2x, 4x, or 8x. Rewind: Wind back the recorded video file. Pause: Briefly stop playing the recorded video file. Play: Play the recorded video file. Faster: Play the recorded video file at the speed of 2x, 4x, 8x, or 16x Next: Go to the next frame by frame. End: Go to the end of the recorded video file.

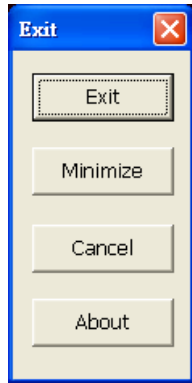

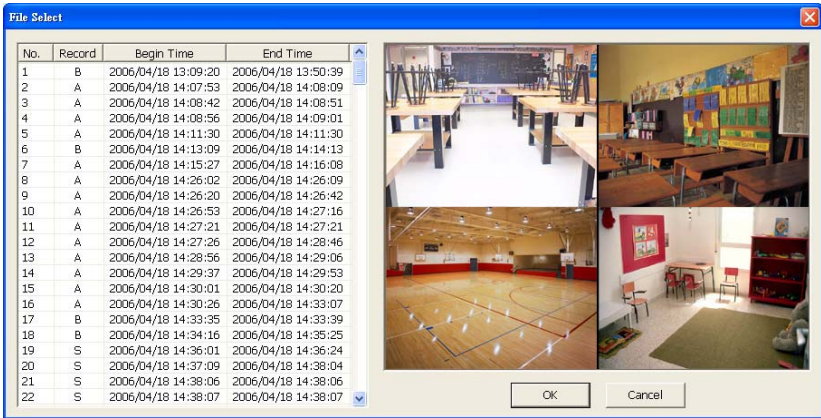
Name	Function
(5) Open File	To select the video file for playing. The playback application supports *.dvr and *.avf file type.  <ul style="list-style-type: none"> - DVR Recorded File (HD): To playback the recorded video from the hard disk which was recording video on the DVR system. (see also Chapter 4.3.2) - Backup File(.dvr): The file is backup and save in *.dvr file format. (see also Chapter 4.3.3)
(6) Status bar	Display the recorded date, time and play speed.
(7) Camera ID	Show the number of cameras that are being viewed. When you are in single screen mode, click the camera ID number to switch and view other camera.
(8) Language	To switch DVR application UI language.
(9) Adv. Function	Advanced function is including : HDD Backup: to call out HDD Backup application. (see also Chapter 5) iEnhance: to call out iEnhance application. (see also Chapter 6)
(10) Export	Export includes Snapshot, Print, Output Video Clip, and Backup function. <ul style="list-style-type: none"> ■ Snapshot: Capture and save the screen shot either in *.jpg or *.bmp format. ■ Print: Print the screen shot. ■ Output to AVI: Save the segmented file in *.mpg or *.avi format
(11) Segment	Keep a portion of the recorded video (see also Chapter 4.3.1)
(12) Full screen	Use the entire area of the screen to only display the video. To return, press the right button of the mouse or ESC on the keyboard. When you switch to full screen in multiple-screen mode, Left click to toggle to only display one of the video in the multiple-screen mode or all.
(13) Event List	Select the event you want to playback. The event list only available when user select to playback in DVR Recorded File(HD) . 
(14) Sound /Sound bar	Turn on and off the sound Increase and decrease the volume
(15) Watermark	To call out Image Verification application. (see also Chapter 7)

4.3.1 To Cut and Save the Portion of the Recorded Video

1. Use the Playback Control buttons or drag the bar on the playback progress bar and pause on where you want to start the cut. Then, click **Segment** to set the begin mark.



2. Use the Playback Control buttons or drag the bar on the playback progress bar and pause on where you want to end the cut. Then, click **Segment** to set the end mark. To cancel segmentation, click **Segment** button again.



3. Click **Output** button to save the wanted portion.
4. In the **Save As** dialog box, locate on where user wants to save the file, type the filename, and select the video format.

4.3.2 Playback DVR Recorded File from Hard Disk

1. Please have the hard disk which containing of recorded video data install on your PC or using external USB enclosure to connect to your PC.
2. Click **Open File** button
3. Select **DVR Recorded File(HD)** and click **OK**.
4. Select the hard disk drive from **Select Disk** window and click **OK**.

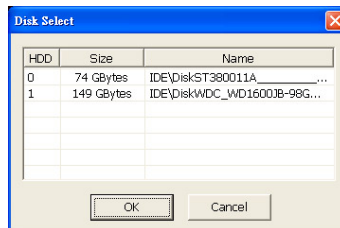

5. And then, the **Event List** window appears. Select the event that user wants to play and click **OK**.

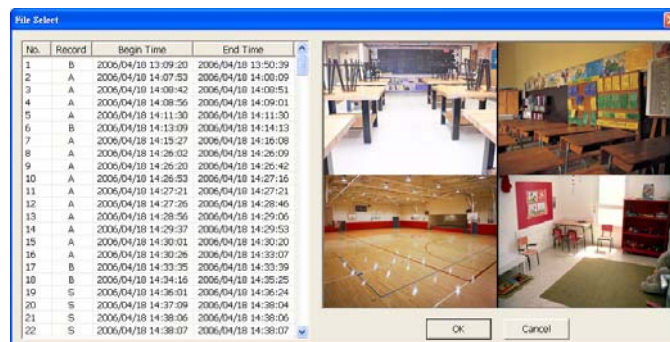

4.3.3 Playback Backup File(*.dvr)

1. Click Open File button.
2. Select **Backup File(*.dvr)** and click **OK**.
3. Locate the backup file folder and click **OK**.



When open the backup video file, just locate the where backup file folder is.

- And then, Playback Date/Time Selection window appears. Select the date and time and click **OK**.

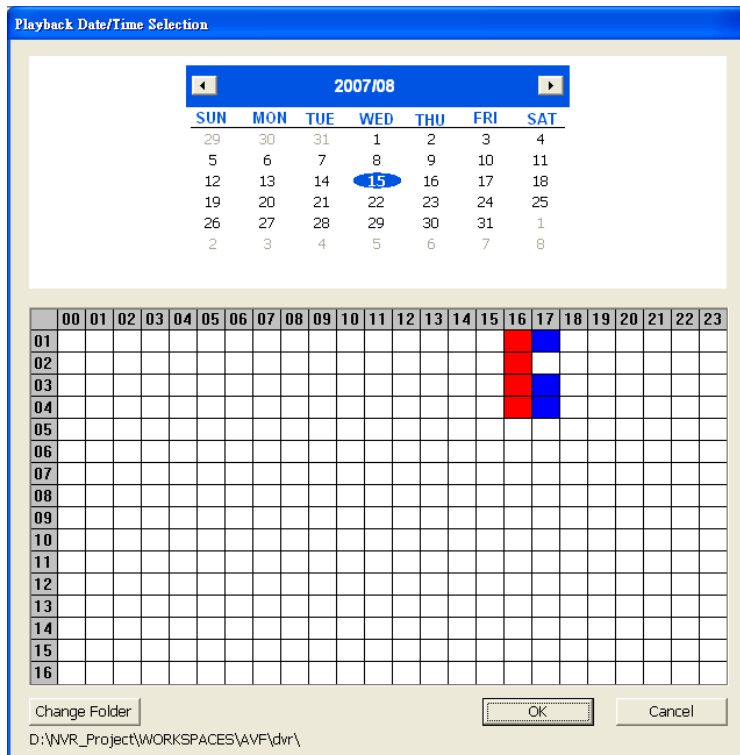

Chapter 5 Backup Recorded Video File

HDD Backup application provides user a interface to view recorded video form hard disk.

5.1 Familiarizing with HDD Backup Application

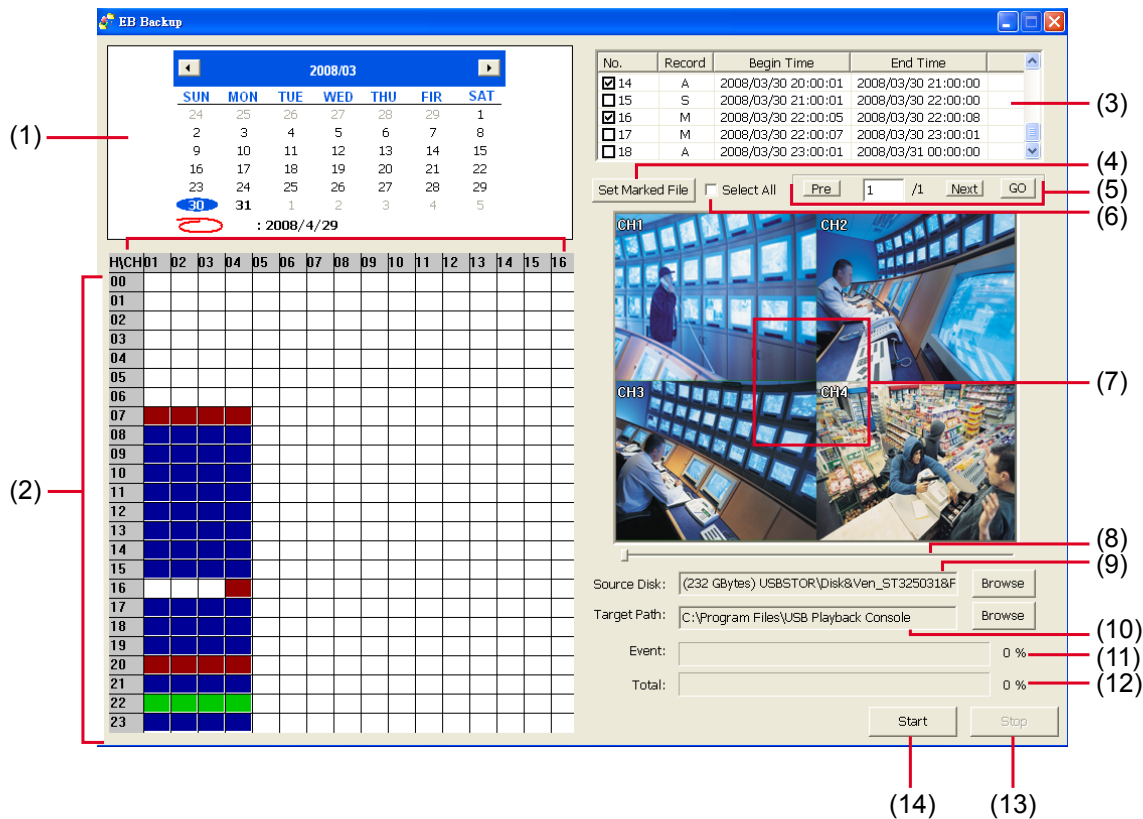

Name	Function
(1) Date	Select the date for events
(2) Hour and Channel	User can select the hour and channel for events. : All events in this hour and channel have been selected. : In this hour and channel has events : Partial of events in this hour and channel has been selected.
(3) Event list	All recorded video events list No.: the list order number Record: the record type(see also Chapter 2.4) Begin Time: the beginning of record time End Time: the end of record time
(4) Set Marked File	Use Ctrl and mouse to select the multiple events from event list, and then click Set Marked File to mark multiple events. When click Set Marked File button, the marked event will turn to un-mark and un-mark event will turn to marked.
(5) Page Switch	Pre: go back last page Next: go to next page Page column: enter the page number and click Go button to go to the page
(6) Select All	Select all listed recorded video events. Click the check box again to cancel for selecting all events.

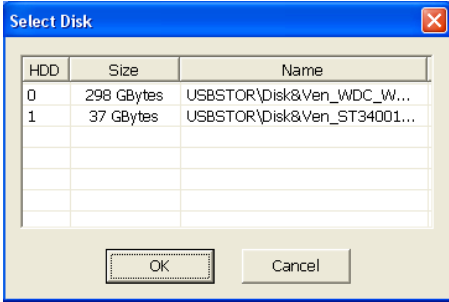
Name	Function
(7) Video display	Display first frame of each recorded video channel from 4 selected.
(8) Progress bar	Show the progress of the event being played. User may move the bar to seek at any location of the track
(9) Source Disk	To select the hard disk drive
	
(10) Target Path	To locate on where user wants to save the file
(11) Event (%)	Display the backup progress rate of event in percentage
(12) Total (%)	Display the total backup progress rate in percentage
(13) Stop	Stop backup progress
(14) Start	Start backup progress

5.2 To Backup Recorded Video File

1. Please have the hard disk which was recording video on the DVR system install on your PC or using external USB enclosure to connect to your PC.
2. To run the HDD Backup application, click the **HDD Backup** button on USB Playback Application main interface.
3. Click **Browse** in **Source Disk** to locate the recorded video file.
4. And then, the **Select Disk** windows will appear as below:

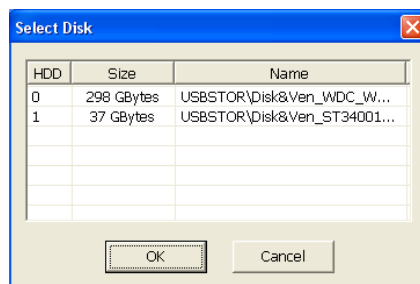

5. Select the hard disk drive from **Select Disk** windows. All available hard disk will list on the **Select Disk** windows with size and name
6. Select the hard disk drive and click **OK**
7. And then, all the recorded video files will list out.
8. Select the event which user wants to backup. Or mark the **Select All** to select all listed recorded video event
9. Locate on where user wants to save the backup file
10. Click **Start** to process backup
11. To stop the backup progress, click **Stop**
12. To play the backup file, see [4.3.3](#).

Chapter 6 ImageVerification

Image Verification is a watermark-checking program to identify the authenticity of a saved image (e.g. by snapshot). This program can only verify uncompressed bmp image files.

6.1 To Run the ImageVerification

1. To run the ImageVerification application, click the **Watermark** button on USB Playback Application main interface.
2. In the ImageVerification screen, click **Load Source Image** and locate the image source.
3. Click **Verify Image** to begin the process.
4. Check the result in the **Processed Image** screen. If the picture is unmodified, the image in the **Source Image** and **Processed Image** screen would be exactly the same. If the picture is being modified, a warning dialog box would prompt and the modified area is highlighted.

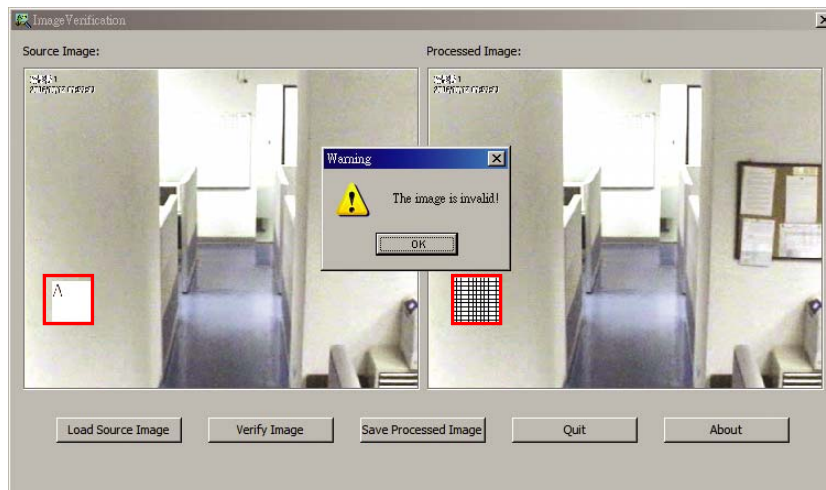

Chapter 7 iEnhance

The bundled iEnhance is a video editing tool and can only be used with *.dvr video file. It allows you to adjust the video picture quality, segment and save the selected portion of the video, zoom in and out the image, and print or save the screen shot. You can also save the setting and apply it on other files.

To run iEnhance application, click **iEnhance** button on USB Playback Console interface.

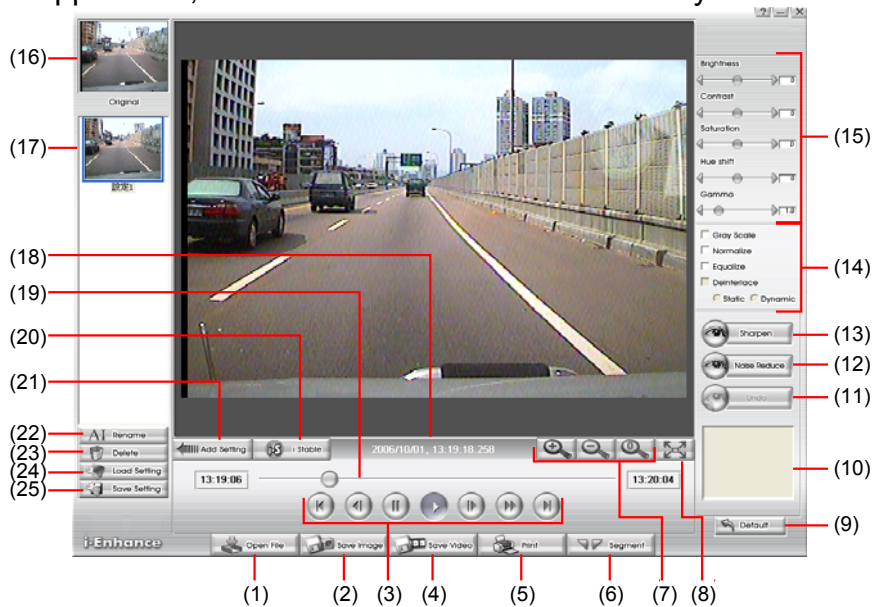

Name	Function
(1) Open File	Access *.dvr video file.
(2) Save Image	Capture and save the screen shot in *.bmp format.
(3) Playback Control Buttons	Begin: Move at the beginning of the video file. Previous: Go back to the previous frame. Rewind: Wind back the video file. Pause: Temporary stop playing the video file. Play: Play the video file. Faster: Play the video file at the speed of 2x, 4x, or 8x. Next: Go to the next frame. End: Go to the end of the video file.
(4) Save Video	Save the edited or segmented video in *.avi format.
(5) Print	Print the screen shot.
(6) Segment	Mark the beginning and the end of the selected portion of the video. Two triangle marks will appear on the slider. To cancel video segmentation, click this button again.
(7) Zoom Buttons	Enlarge, reduce, and set the image back to normal size.
(8) Full Screen	Use the entire screen to only display the video.
(9) Default	Set the video back to original state and delete all the changes in the history box.
(10) History Box	List all the actions.
(11) Undo	Delete the last action.

Name	Function
(12) Noise Reduce	Adjust the softness and repair the damaged colours.
(13) Sharpness	Improve the overall image by enhancing edges. This gives the image more depth.
(14) Effects	Gray Scale: convert the image into black and white (monochrome). Normalize: adjust the brightness intensity. Equalize: automatically adjust the images that are too dark. De-interlace: smooth out the overlying frames. Static: de-interlace for motionless scene. Dynamic: de-interlace for moving scene.
(15) Picture Adjustment	Adjust the Brightness, Contrast, Saturation, Hue and Gamma.
(16) Original Screen	Display the original state of the image.
(17) Temporary Setting Block	Display the sample settings. Click the sample to apply the setting on the current video.
(18) Status Bar	Display the date, and time of the video.
(19) Progress Bar	Show the progress of the file being played. You may move the bar to seek at any location of the track.
(20) iStable	To reduce the jolt in the recorded video.(also see Chapter 7.1)
(21) Add Setting	Include the new setting to the temporary setting block.
(22) Rename	Change the name of the selected setting in the temporary setting block.
(23) Delete	Permanently remove the selected setting in the temporary setting block.
(24) Load Setting	Call the saved settings.
(25) Save Setting	Store the settings in the temporary setting block.

7.1 To Use iStable

The iStable function can reduce the jolt in the recorded video.

1. Click **Open File** button and select the recorded video.
2. And then, click **iStable** button.
3. iStable windows will show up.
4. Select the **smoothness** level – 1(Low), 2, 3, 4, and 5(High). The default value is 3.
5. Click Play button, and then iStable function will start to initial the recorded video.
6. When the initialize is done, user will see the original and stabilized recorded video play in two windows.

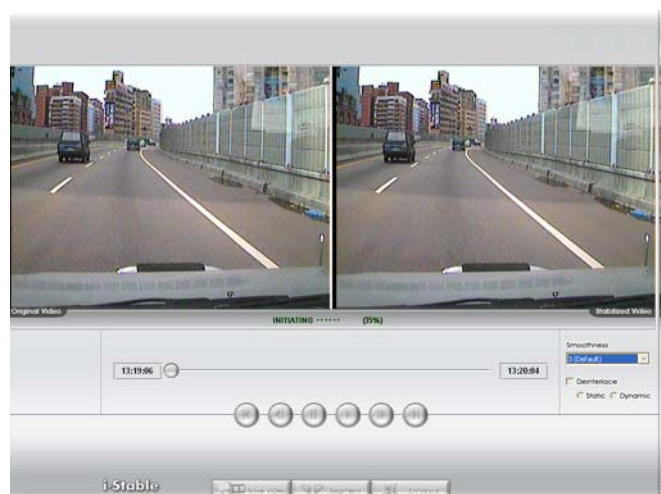

Chapter 8 Using the Remote Programs

User can use Microsoft Internet Explorer to access DVR system by entering the IP address. To use this feature, make sure that you PC and EB 1304 NET both are connected to the internet and the Network feature is enabled.

Accessing this feature for the first time you will be prompted by your browser to install WebCamX.cab, allow the installation and you should be able to connect and login afterwards. For Windows 2000, click **Yes** when the Security Warning dialog box appears.

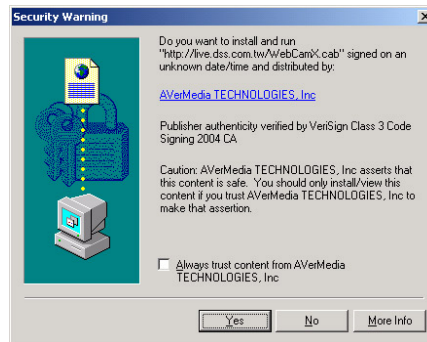

For Windows XP, click Install when the Internet Explorer - Security Warning dialog box appears.

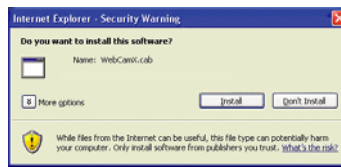

After installing the WebCamX.cab and when connecting to the DVR system, you are required to enter User ID (Superuser or User) and password (default password is 111111) and select the type of network. Superuser has the authority to remote setup the DVR system configuration on Web Viewer.

-  - If user can not connect to DVR server, it might be the IP address of DVR server is conflict with IP address of any PC at network. Please contact the manager of DVR server to reconfigure IP address of DVR server. Please reconnect with DVR server again when the IP address conflict is solved
- Changing the Superuser and User default password is strongly recommended.

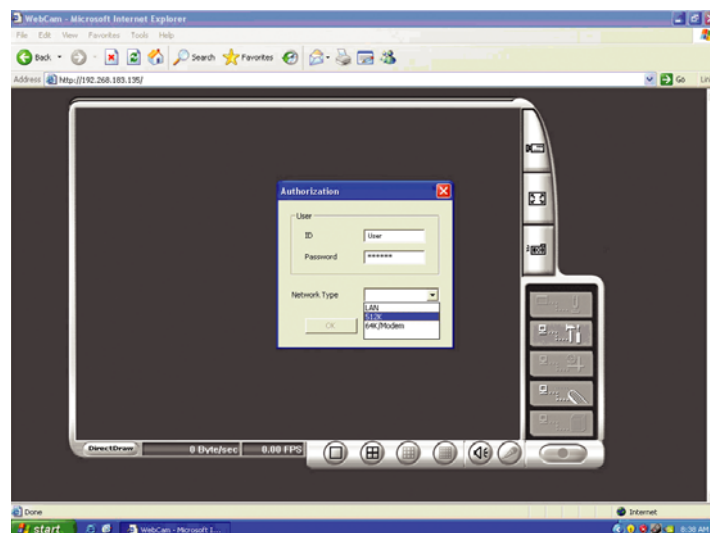

8.1 Familiarizing the Web Viewer Buttons

Right-clicking on the Web Viewer video screen, enables you to start video recording, change video quality, switch camera and enable/disable DirectDraw.

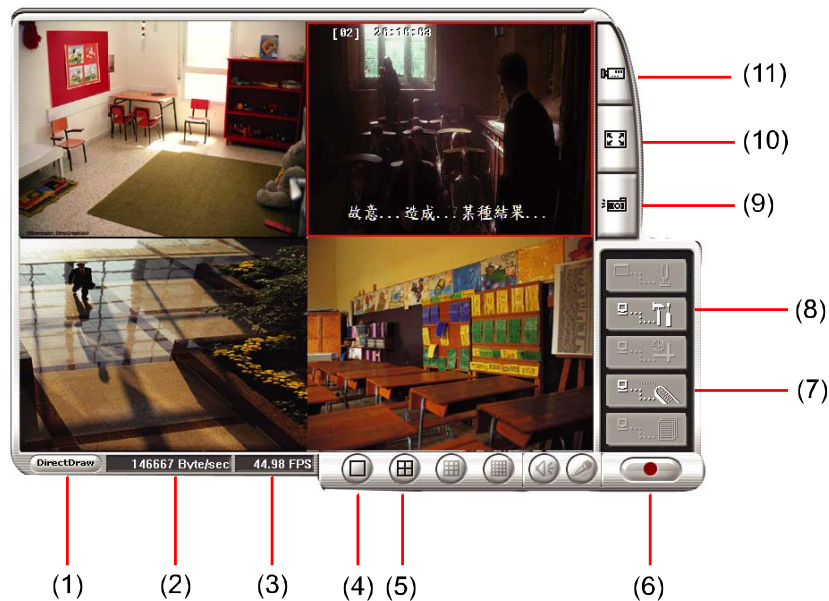

Name	Function
(1) DirectDraw	Enhance the video quality.
<p>i Not all graphic cards can support this function. If you can not see the screen display correctly or screen is messed, please check with VGA card vendor.</p>	
(2) Received file size	Indicate the size of the data being sent per second.
(3) Camera frames	Indicate the number of frames per second.
(4) One screen view	To view single camera view on screen. User can right click on the screen to switch to different camera view.
(5) Split screen view	To view 4 camera on screen simultaneously.
(6) Record	Start to record the video of the selected camera in AVI format. Directly click screen to select the channel that user wants to record and press Record button.
(7) Remote Console	Initiate Remote Console. It allows you to control DVR server (see also Chapter 8.2).
(8) Remote setup	Change the DVR server settings (see also Chapter 8.1.1).
<p>i Only Superuser has the authority to remote setup DVR system.</p>	
(9) Snapshot	Capture and save the screen shot in *.bmp format.
(10) Full screen	Use the entire area of the screen to only display the video. To return, Right click the mouse or press ESC on the keyboard.

Name	Function
------	----------

(11) Select cameras to view

Select to the view camera from different server. In **Select Camera** dialog box, Display column, click to enable/disable viewing the camera.
 Click **Add Server** and select the server type between DVR and IP Cam to add.
 Click **Delete Server** to delete the selected item.
 Click **Import** to load the previous saved list.
 Click **Export** to save the list.
 Click **Apply All** to change all the camera video quality based on the selected setting.
 Click **OK** to exit.

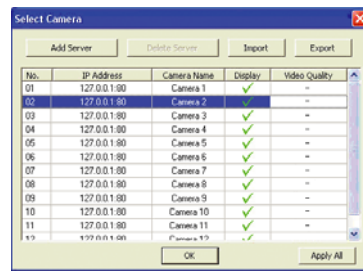

8.1.1 To Setup Remote System Setting

Click **OK** to exit and save the setting and **Cancel** to exit without saving the setting. The setting here applies to Remote DVR only.

i After changed the DVR system setting, refresh your web browser in order to apply the new setting to the DVR system.

8.1.1.1 Camera Setup

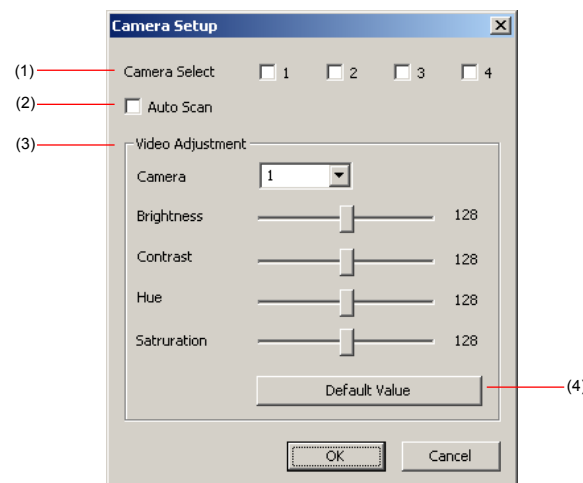

(1) Camera Select:

Enable/disable the channel number to display the video on the surveillance screen

(2) Auto Scan

Enable/disable auto cycle switch to display the next channel when in full screen preview.

(3) Video Adjustment

Select the camera and adjust the Brightness, Contrast, Hue and Saturation of the selected camera.

(4) Default Value

Set the video value back to default

8.1.1.2 Record Setup

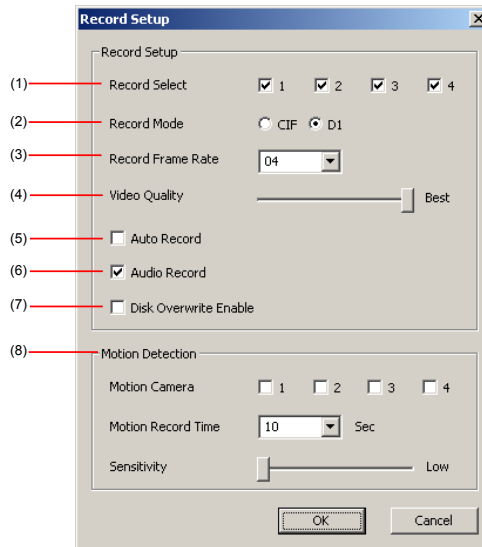

(1) Record Select

Enable/disable the channel number to record video



The channels which could be recorded should be enabled in the CAMERA SELECT first.

(2) Record Mode

Select D1/CIF recording mode. Under D1 mode, the video recording is in full screen resolution. Each channel is recorded at a maximum frame rate of 15fps. You can switch to view the video in single full screen or 4 split screen. Whereas in CIF mode, video recording is at a lower resolution, but each video is recorded in 30fps/25fps (NTSC/PAL).

(3) Record Frame Rate

Set the number of frames per second to be recorded. Refer to the table below for the available record frame rate settings. The higher the frame rate is, it uses more hard disk space

Video Standard \ Record Mode	NTSC	PAL
D1	60, 20, 4	48, 20, 4
CIF	120, 60, 40, 20, 4	100, 48, 20, 4

(4) Video Quality

Select the video quality setting from BEST, HIGH, MEDIUM, GOOD, NORMAL or LOW.

(5) Auto Record

Enable/disable auto continue recording when interrupted (i.e., power breakdown, video playback or configuration setup). It continue recording after 10 second of idleness. This is applicable in Always Record mode under schedule setting.

(6) Audio Record

Enable/disable audio recording. To record sound, make sure the microphone is connected to the unit

(7) Disk Overwrite Enable

Enable/disable replacing the earliest record when the hard disk space runs out. By default, the HDD overwrite setting is enabled

(8) Motion Detection

- Motion Camera

Enable/disable the channel number to detect motion.

- Motion Record Time

Set the amount of time (in second) to record when a motion has detected.

- Sensitivity

Set the sensitivity level. The sensitivity is from high, 9~ 2 and low.

8.1.1.3 Alarm/Sensor Setup

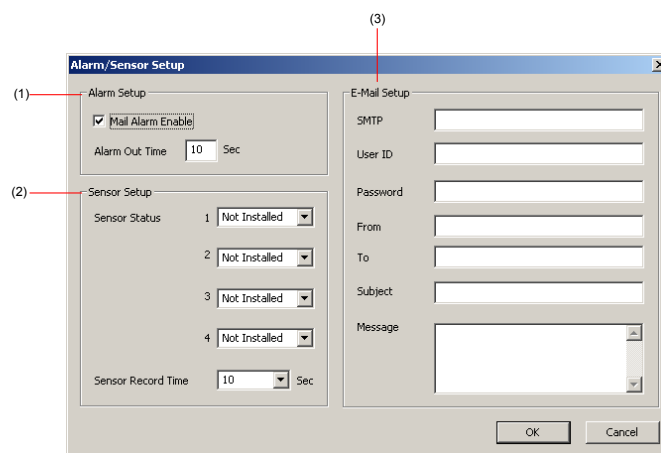

(1) Alarm Setup

- Mail Alarm Enable

Enable/disable alarm sending mail when alarm has triggered or motion has detected.



The Motion Detection must be enabled first, the alarm sending mail will send out the mail when detect motion.

- Alarm Out Time

Set the amount of time (in second) to continue sending the alarm once activated

(2) Sensor Setup

- Sensor Status

Customize the initial state of the attached sensor for every camera. Refer to the table

below to customize the sensor state.

Not installed: Indicates that there is no sensor connected

Normal open: Indicates that the initial state of the sensor is normal open. Video recording initiate when there is a changes in the sensor state

Normal close: Indicates that the initial state of the sensor is normal close. Video recording initiate when there is a changes in the sensor state

- **Sensor Record Time**

Set the amount of time (in second) to record after the sensor has been triggered

(3) E-Mail Setup

- **SMTP**

Enter the SMTP server

- **User ID & Password**

Enter User ID and Password for e-mail server user identification

- **From**

Enter the sender e-mail address

- **To**

The recipient e-mail address and separate it with a semicolon

- **Subject**

Enter the message title

- **Message**

Type the message

8.1.1.4 Network Setup

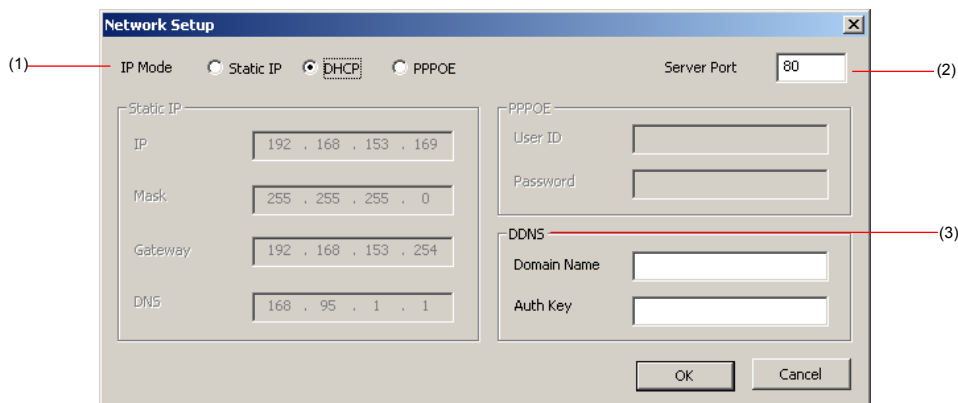

(1) IP Mode

- **Static IP**

Assign a fixed and global IP address for the DVR system

IP: Assign a constant IP address which real IP addresses give from ISP.

Mask: Enter the subnet mask of the IP address which user has assigned to DVR system.



It is a bitmask used to tell how many bits in an octet(s) identify the subnetwork, and how many bits provide room for host addresses.

Gateway: Enter the network gateway IP address

DNS: Domain Name Server translates domain names (such as www.abb.com.tw) to IP addresses. It will translate the domain name into IP address when DVR system request.

- **DHCP**

Assign the IP address by local DHCP server to DVR system.



The Dynamic Host Configuration Protocol (DHCP) is a set of rules used by a communications device (such as a computer, router or networking adaptor) to allow the device to request and get an Internet address from a server which has a list of addresses available for assignment.

- **PPPOE**

Point-to-Point Protocol over Ethernet is a network protocol for encapsulating PPP frames in Ethernet frames. It is used mainly with ADSL services.

(2) Server Port

A port is using for the remote connection. Any port can be assigned as a server port, except the ports already used by the network services. For the network service ports that use by DVR server, please see [Appendix C](#).

(3) DDNS

DDNS (Dynamic Domain Name Service) is a data query service mainly used on the Internet for translating domain names into Internet addresses. Users can register their own domain name on <http://ddns.avers.com.tw>. (See [Appendix A](#))

- **Domain Name**

Enter the domain name that user has registered.

- **Auth Key**

A password use to access DDNS that user has setup when register the domain name.



- To register a domain name, please refer to [Appendix A](#).
 - Please restart DVR system in order to active DDNS service.
-

8.1.1.5 Password Change

Click **Remote setup** button on Web Viewer main interface, and then, click **User** button to call out the **Password Change** interface.

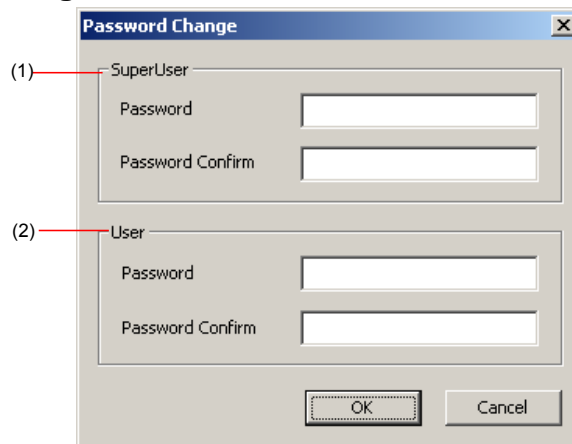

(1) Superuser

Change the remote accessing password of super user. Superuser has the authority to remote setup the DVR system configuration on Web Viewer.

- **Password**

Enter the new password

- **Password Confirm**

Re-enter password to confirm

(2) User

Change the remote accessing password of user

- **Password**

Enter the new password

- **Password Confirm**

Re-enter password to confirm

8.2 Familiarizing the Remote Console Buttons



Name	Function
(1) Exit	Close the Remote Console.
(2) Audio button	Enable/disable the sound.
(3) Split Screen Mode	Select from six (6) different split screen type to playback the recorded video file of all the camera, or one camera over the other or alongside on a single screen.
i	<ul style="list-style-type: none"> - If there are only 4 cameras, you won't be able to switch to 9, 16, and 13 split screen mode. - To change the video quality, right-click on the screen and select between High, Normal or Low.
(4) Record	Start/stop video recording.
(5) Network	Enable/disable remote system access. This feature allows you to access EB DVR server from a remote location via internet connection.
(6) Setup	Configure the Remote Console setting. (see also Chapter 8.2.1)
(7) Preview	Switch to Preview/Playback mode. This allows you to view live camera display.
(8) Playback	Switch to Playback mode. This allows you to view the recorded video file. (see Chapter 8.3)
(9) Status Bar	Display the current date, time and hard disk free space.
(10) Camera ID	Show the number of cameras that are being viewed. When you are in single screen mode, click the camera ID number to switch and view other camera.
(11) Snapshot	Capture and save the screen shot either in *.jpg or *.bmp format.
(12) Full screen	Use the entire area of the screen to only display the video. To return, Right click the mouse or press ESC on the keyboard.
(13) DirectDraw	Enable/disable DirectDraw function
i	Direct Draw function supports for certain VGA card. For more information, please contact your VGA card vendor.

8.2.1 To Setup Remote Console Setting

Click **Setup** button to call out the **System Setting** windows. Click **OK** to exit and save the setting and **Cancel** to exit without saving the setting.

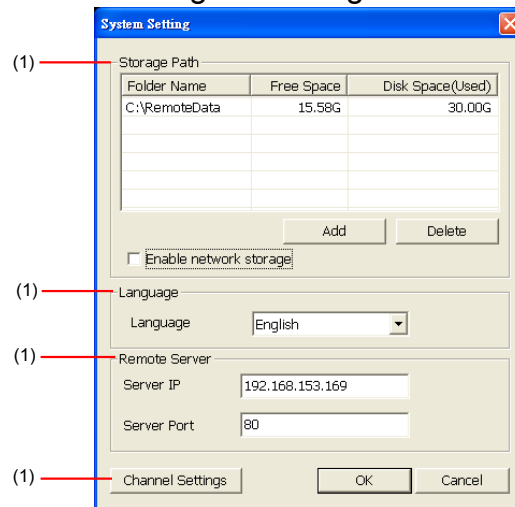

(1) Storage Path

Set the directory on where to save the data. When there is not enough free space to record one hour data, the system automatically replaces the oldest data. In case you have more than one storage path, the system automatically saves the data to the next storage path. By default the data is stored in C:\RemoteData, to insert another storage path, click **Add**. To remove the selected path, click **Delete**.

- **Enable** network storage

Select the Enable network storage check box to send the recorded video in network-attached storage.



To add network storage, the Internet storage drive/folder must be mapped as Network Driver in DVR server. To know how to assign or connect to a network drive, please refer to your Windows help file and search "Map Network drive".

(2) Language

Customize the system to display the tool tips and dialogs based on the selected language. By default the language is in English.

(3) Remote Server

Enter the DVR Server IP and Server Port number.

(4) Channel Settings

The numbers from 1 to 4 represent the camera ID. In Transmitting Channels section, enable the camera number to receive the camera signal from the server. In Visible Channels section, enable the camera number to view the camera signal on Remote Console screen. To select all the cameras, enable the **ALL** check box.

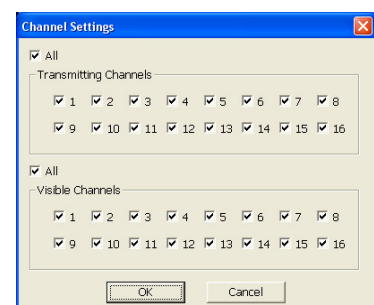

8.3 Using the Remote Playback

To use this feature, first you need to select the source of the file. Click the **Playback** button. And then, in the Select Playback Mode dialog box, choose **Local Playback** to open the file that is recorded in the Remote Console, and **Remote Playback** to open the file that is recorded in the DVR server. When you choose Remote Playback, select **Download and Playback**.



Click **OK** to proceed and **Cancel** to void this operation.

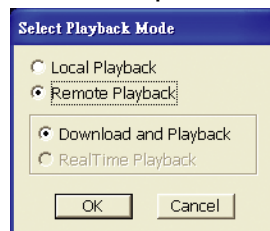

In the Video Playback Date/Time Selection, the number from 00 to 23 represent the time in 24-hour clock. The numbers from 01 to 16 represent the camera number.

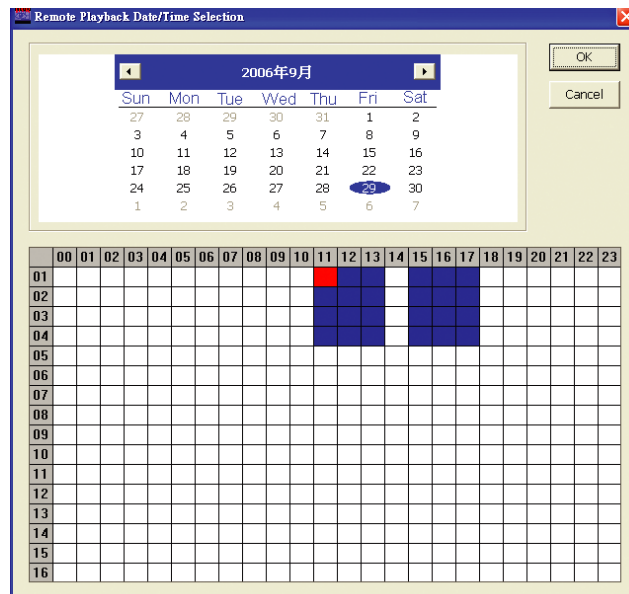

To Make a Selection:



1. Select the date in the calendar. Use and buttons to shift the calendar to the left or right.
2. In the table below, click on the blue block to select and open the recorded file. The blue block turns red when it is selected. The block that appears in white doesn't have data. You can only select one block when you choose Download and Playback.
3. Click **OK** to proceed and **Cancel** to void this operation.

4. If you select Download Playback and after making the selection, the system divides the selected hour into 16 video thumbnails. In the Time Selection screen, click on the video thumbnail you want to download (see also [Chapter 8.3.2](#)).

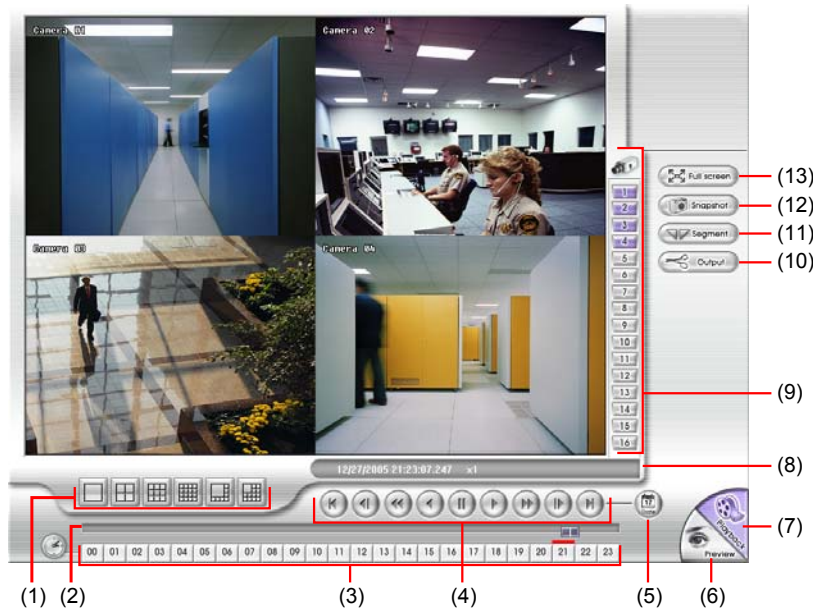

8.3.1 Familiarizing the Local Playback Buttons



Name	Function
(1) Split Screen Mode	Select from six (6) different split screen type to playback the recorded video file of all the camera, or one camera over the other or alongside on a single screen.
	<ul style="list-style-type: none"> - If there are only 4 cameras, you won't be able to switch to 9, 16, and 13 split screen mode. - To zoom in an area on the screen, Right click and Drag a square on the area you want to enlarge. To back to normal view, right click the channel screen again.
(2) Progress bar	Show the progress of the file being played. You may move the bar to seek at any location of the track.
(3) Hour Buttons	Select and click to playback the recorded video file on the specific time frame.
	The Hour buttons represent the time in 24-hour clock. The blue bar on top of the hour button indicates that there is a recorded video file on that period of time. If there is no recorded data within the hour, there will be no color bar on top of the hour button. While the red bar indicates that you are currently viewing the recorded video file.

Name	Function
(4) Playback Control Buttons	<p>Begin: Move at the beginning of the recorded video file.</p> <p>Previous: Go back to the previous frame.</p> <p>Slower: Play the recorded video file at the speed of 1/2x, 1/4x, or 1/8x.</p> <p>Rewind: Wind back the video file.</p> <p>Pause: Briefly stop playing the recorded video file.</p> <p>Play: Play the recorded video file.</p> <p>Faster: Play the recorded video file at the speed of 2x, 4x, or 8x.</p> <p>Next: Go to the next frame.</p> <p>End: Go to the end of the video file.</p>
(5) Date	Select the date on the calendar and the time from 00 to 23 to where to start playing the recorded video file.
	The numbers from 00 to 23 represent the time in 24-hour clock. The numbers from 01 to 16 represent the camera ID. While the red colored column indicates on where to start playing the recorded video file. If there is no any video data, it will be no color bar on top of the date button.
(6) Preview	Switch to Preview/Playback mode.
(7) Playback	Switch to Playback mode. This allows you to view the recorded video file.
(8) Status bar	Display the record date, time, HDD capacity in preview mode and play speed in playback mode.
(9) Camera ID	Show the number of cameras that are being viewed. When you are in single screen mode, click the camera ID number to switch and view other camera.
(10) Output	Save the segmented file in *.mpg, *.avi, or *.dvr format (see also Chapter 8.3.1.1).
(11) Segment	Keep a portion of the recorded video you want (see also Chapter 8.3.1.1).
(12) Snapshot	Capture and save the screen shot either in *.jpg or *.bmp format.
(13) Full screen	View in Playback-compact mode. To return, press the right button of the mouse or ESC on the keyboard.

8.3.1.1 To Cut and Save the Wanted Portion of the Recorded Video

1. Use the Playback Control buttons or drag the bar on the playback progress bar and pause on where you want to start the cut. Then, click Segment to set the begin mark.



2. Use the Playback Control buttons or drag the bar on the playback progress bar and pause on where you want to end the cut. Then, click Segment to set the end mark. To cancel segmentation or set the segment marks from the start, click Segment button again.



3. Click Output button to save the wanted clip.
4. In the Save As dialog box, locate on where you want to save the file, type the filename, and select the video format.

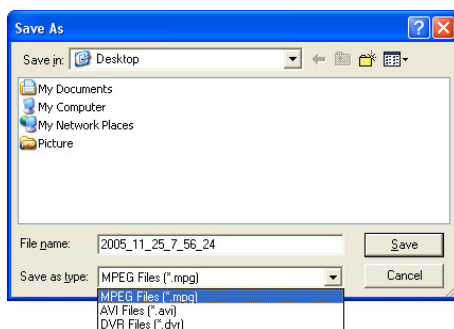

8.3.2 Familiarizing the Download and Playback Buttons



Name	Function
(1) Progress bar	Show the progress of the file being played. You may move the bar to seek at any location of the track.
(2) Playback Control Buttons	<p>Begin: Move at the beginning of the video file.</p> <p>Previous: Go back to the previous frame.</p> <p>Slower: Play the recorded video file at the speed of 1/2x, 1/4x, or 1/8x.</p> <p>Rewind: Wind back the video file.</p> <p>Pause: Briefly stop playing the recorded video file.</p> <p>Play: Play the recorded video file.</p> <p>Faster: Play the recorded video file at the speed of 2x, 4x, or 8x.</p> <p>Next: Go to the next frame.</p> <p>End: Go to the end of the video file.</p>
(3) Date	Open other file.
(4) Output	Save the segmented file in *.mpg or *.avi format.
(5) Print	Print the screen shot.
(6) Save	Save the screen shot either in *.jpg or *.bmp format and video in *.dvr format.
(7) Segment	Keep a portion of the recorded video you want. You may follow the instruction in Chapter 8.3.1.1 .

Chapter 9 Using Central Management System

AVerMedia® CM3000 is a central management system that enables user to monitor up to 1000 DVR servers (optional) through an internet connection. The CMS system also automatically records and displays video when an event has occurred on the remote side of the DVR server. You can also playback video files locally or download from a remote DVR server. The CMS system Supports Single, Dual, Triple, and four monitor displays. User can operate the CMS system application on different monitors. For dual monitor setup, please refer to [Appendix B](#).

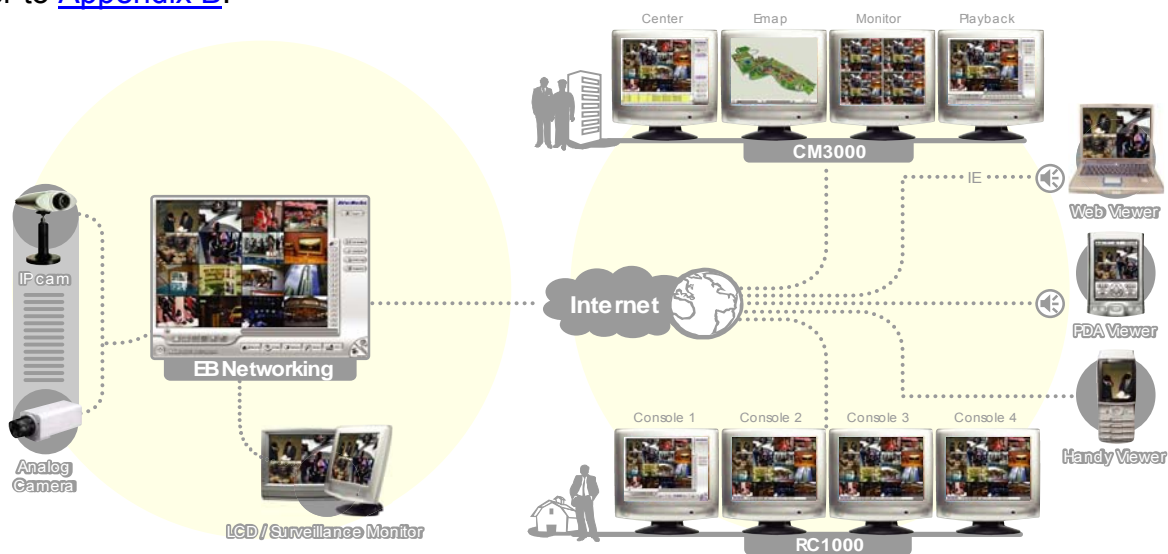

9.1 Software Installation

This section describes how to install the CM3000 software.



Before installing the software, make sure the Windows OS patches are up to date and the video graphic card driver is up to date.



For Windows 2000, make sure the hyper-threading setting is DISABLED from the PC BIOS system.

9.1.1 Minimum System Requirements

First, must verify if the computer meets the minimum system requirements.

- CPU : Pentium® 4 3.0GHz or above recommended
- OS : Windows 2000 / XP Professional
- RAM : 512MB for dual display, 1GB for Quad display
- Hard disk : 120GB or higher
- Media : CD-ROM drive
- VGA : 32-bit high color SVGA graphics card with 128MB video memory and DirectDraw® / YUV Rendering Capability
- Audio : Sound card and speakers
- Internet capacity : 10/100/1000 Base-T Ethernet card or Gigabit Ethernet

9.2 Installing the CM3000 in Windows XP/2000

1. Place the installation CD into the CD-ROM drive then click **Utility**. And select the CM3000 folder and click **setup.exe**. And then, follow the on-screen instructions.
2. Please carefully read the license agreement. Click **Yes** to accept the agreement.
3. Enter the administrator ID and password for entering CMS system.

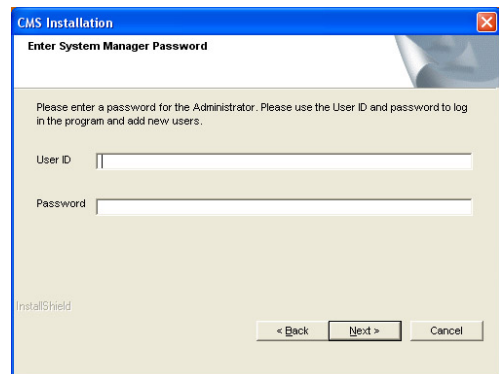
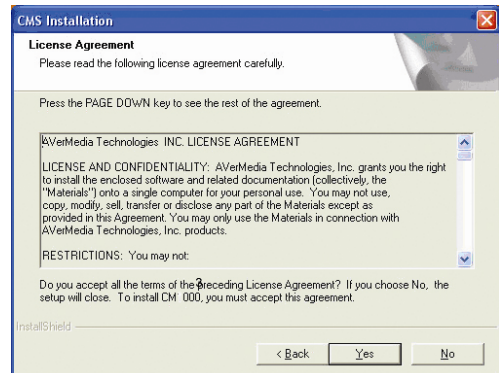

4. Click **Finish**.

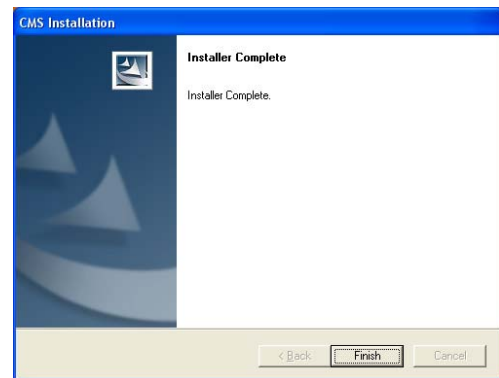

5. User may now run the CMS program. To run the application, click  on your PC desktop or click **Start>Programs >DSS>CMS > CMS3000**.

9.3 Using the CM3000

9.3.1 Running the CM3000 Software

To run the application, double-click  on your PC desktop or click **Start > Programs > DSS > CMS > CM3000**.

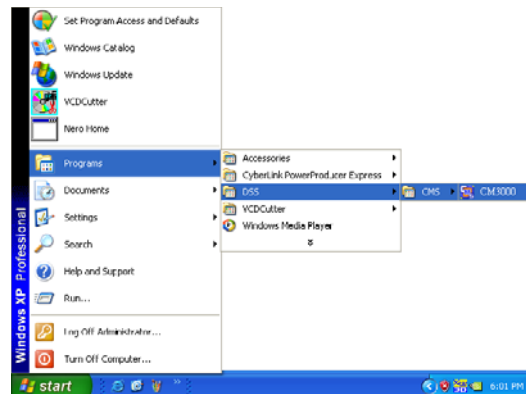

For security purposes, some of the features would require you to enter a User ID and Password before they can be accessed. When the Authorization dialog box appears, key in your User ID and Password. (If it is the first time to enter CMS system, enter the user ID and password that you have registered when installing the software.)

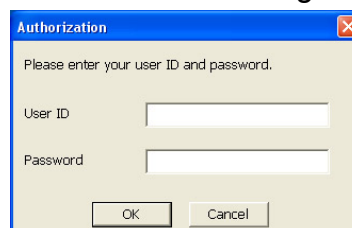

9.3.2 Using the CMS Application

When an alarm occurred on the DVR server, the video is transmitted to the CMS and played on the CM3000 main screen. The transmitted video is approximately 3 seconds long. You may download and playback the complete video directly from the DVR server. The video stream before the eye indicates the latest occurrence. Also, there is a red frame which indicates the latest occurrence.

i For the best video play quality, we recommend that user set the record frame rate at 60fps in EB1304 NET system(also see [Record Frame Rate in Chapter 3.1 Menu Function](#))

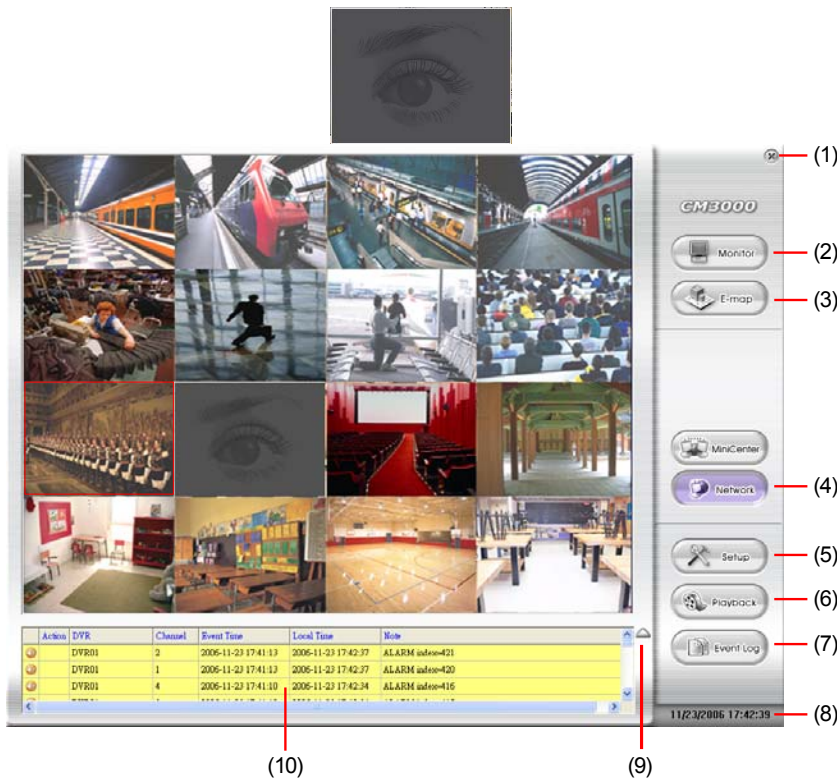

Name	Function
------	----------

(1) Exit

Call up the Logout dialog box.

In the logout dialog box, you may do the following:

- Click **Exit** to close the CMS program. Only the administrator is authorized to access this command.

- Click **Login** to sign-in as a different user.

- Click **Cancel** to close the Logout dialog box.

Click **About** to find out more about the software and register the CMS application.

Click **Register** to call out the registration window. Enter the serial number in the **Serial number** column and click **OK** to complete the registration.

Name	Function
------	----------

(1) Exit

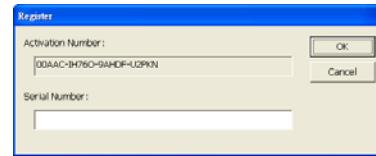
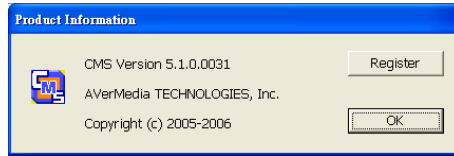

To get the serial number, please contact your local dealer and give activator key of product. And then, user will have the serial number to complete product registration and also CMS system will be upgraded to 1000 DVR servers management.

(2) Monitor (F4)

Switch to display live video from the selected DVR servers group. If user is using a single monitor, press **ESC** to revert back to the CMS main application.

(3) E-map (F3)

Switch to display the map and show the location of the NV DVR server on the map. If you are using a single monitor, press **ESC** to revert back to the CMS main application.

(4) Network

Enable/disable the remote alarm data received. This is activated automatically when the CM software starts up. The network is using port 80 so please make sure you are not running any web server or application that locks port 80 on the PC with the CM3000 software.

(5) Setup

Configure the CMS system settings. Only the administrator is authorized to access this command. (see also [Chapter 9.4.1](#))

(6) Playback

Select to playback video from the local hard disk or remote DVR server.

(7) Event log

Show a record of activities that has taken place in the system (see also [Chapter 9.5.4](#)).

(8) Status

Display the current date, and time

(9) Log extender

Expand and reduce the log viewer

(10) Log viewer

List the entire info in event mode or text mode from all DVR servers.



There are a few Hot keys for quick switching between the different applications or display mode on a single monitor system.

- F1: displays current DVR server information on the CMS application main screen
- F3: Switches to E-Map mode
- F4: Switches to Monitor mode
- Esc: Switches back to the CMS application main screen

9.4 Customizing the CMS System

In the CMS application, click the  button to customize the CMS system. When the CMS configuration setup selection appears, select and click the buttons you want to change the setting.



9.4.1 System Setting

In the System Setting dialog box, click **OK** to accept and start to reload the new setting, and **Cancel** to exit without saving.

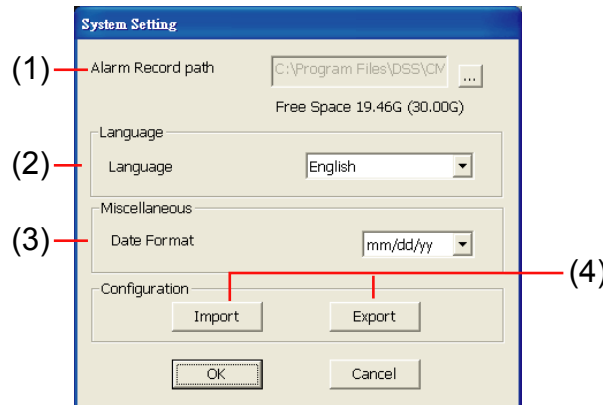

(1) Alarm Record Path

By default, the alarm folder is automatically generated to where the CMS application is installed and for saving the alarm clip videos and log files. The suggested hard disk capacity for storing the recorded video is 30GB (see also [9.4.1.1](#))

(2) Language

Customize the system to display the tool tips and dialogs based on the selected language. By default the set language is in English (see also [9.4.1.2](#))

(3) Miscellaneous

Date Format - Select from different date formats (see also [9.4.1.3](#))

(4) Configuration

Import / Export the CMS system configuration

9.4.1.1 To change the Alarm Record Storage Path

1. Click **Setup**.
2. In the Authorization dialog box, enter the administrator User ID and Password.
3. Click **System** > . In the Browse For Folder dialog box, locate where you want to store the alarm video clip. Click **Make New Folder** to create new folder, **OK** to accept and **Cancel** to exit.



4. The text below the Alarm Record path text box shows the hard disk free space and total space in parenthesis.

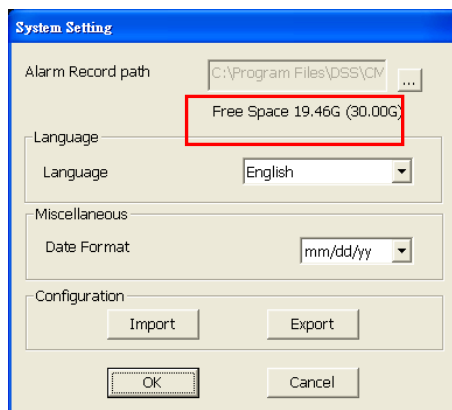

5. In the System Setting dialog box, click **OK** to start reloading the new setting and **Cancel** to exit without saving the new setting.

9.4.1.2 To Set the System to a Different Language

1. Click **Setup**.
2. In the Authorization dialog box, enter the administrator User ID and Password.
3. Click **System**.
4. In the Language drop down list, click and select the language.

9.4.1.3 To Change the Status Date Format

1. Click **Setup**.
2. In the Authorization dialog box, enter the administrator User ID and Password.
3. Click **System**.
4. In the Date Format drop down list, click and select the style.
5. In the System Setting dialog box, click **OK** to accept the new setting and **Cancel** to exit without saving the new setting.

9.4.2 DVR Setup

Display the list of all DVR servers. User may add up from 16 to 1000 DVR servers, delete and modify the DVR setting.



To monitor up to 1000 DVR servers may vary on CMS support. Please confirm with your local dealer for more information.

9.4.2.1 To Add and Remove DVR Server

1. Click **Setup**.
2. In the Authorization dialog box, enter the administrator User ID and Password.
3. Click **DVR**.
4. In the DVR Setup section, click **Add** to insert, **Delete** to remove and **Edit** to modify DVR server setting.

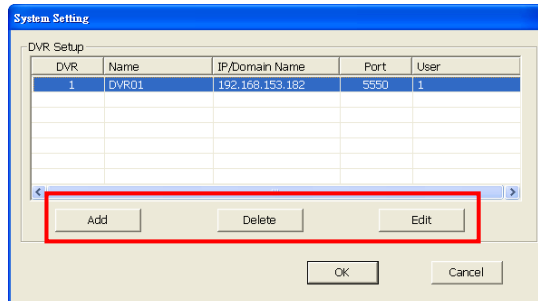

5. To continue adding a DVR, in the text box, enter the **Name**, **IP/Domain**, **Login User**, **Password**, **Confirm Password** of the remote DVR server.
6. If necessary, fill up the contact information to let the personnel in the CMS side know whom to get in touch with when an event has occurred.
7. Set the **Storage Path** for saving the recorded video data of the selected cameras on the Monitor screen.
8. Set the max video recorded storage capacity of this DVR server on the CMS system server. Enter the value in **Quota**.

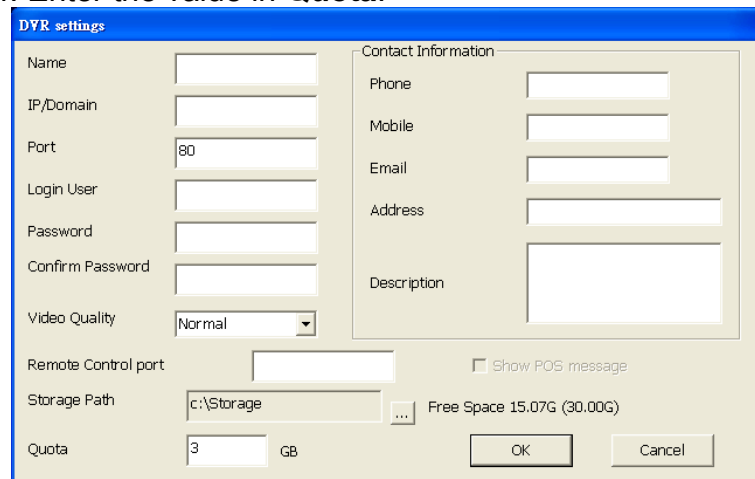

9. In the **DVR Setting** dialog box, click **OK** to accept the new setting and **Cancel** to exit without saving the new setting.

9.4.3 Camera Setup

Select the camera from different DVR servers in order to monitor on same screen. The selected cameras will be play on **Monitor** screen (see [Chapter 9.3.2 # 2](#)).

1. Click **Setup**.
2. In the Authorization dialog box, enter the administrator User ID and Password.
3. Click **Camera**.
4. Select the DVR server. And then the cameras of the DVR server will display on the

Camera Select window.

5. Select the camera that user wants to add, and then click **Add** button. The camera will be added to **Monitor Layout** window. User can add up to 64 cameras by select the camera display format from **4x4**, **5x5**, **6x6**, **7x7**, and **8x8** format. To remove the camera from the **Monitor Layout** window, select the camera and click **Delete** button. To delete all cameras, click **Clear All** button.
6. To record the cameras video, mark the **Record** box. Otherwise, the cameras video will not be saved on the CMS system hard disk. When playback the recorded camera video, user need to select the DVR server.
7. Click **OK** to save the setup. To exit without saving, click **Cancel**.

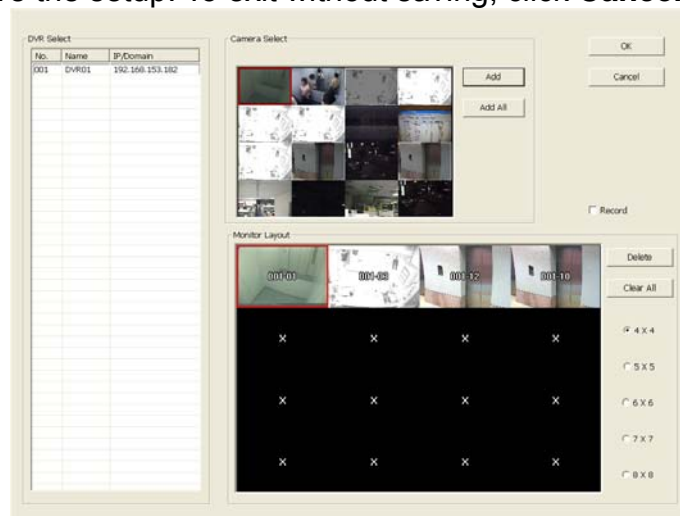

9.4.4 E-MAP Setup

Holds up to 64 maps in *.bmp/*.jpg format. The map is hierarchy in structure and users can add a map on another map. User also may add the DVR icons on the map.

9.4.4.1 To Set Up the E-Map

1. Click **Setup**.
2. In the Authorization dialog box, enter the administrator User ID and Password.
3. Click **E-Map**.
4. The E-Map interface will show up in second monitor if user is using multiple monitors for the CMS system. If user is using single monitor for the CMS application, the E-Map interface will show up in front of the CMS application interface. Press **Esc** to switch back to CMS application interface or press **F3** to switch to E-Map interface again.
5. On the E-Map interface:
 - (1) go back to previous layer of map
 - (2) Show the current name and layer of map
 - (3) Load a map to replace the current map
 - (4) Add a new map. The new map is added on the current map as a next level.(See [Add a New Map](#))
 - (5) Display the selected Map or DVR server information.
 - (6) Add a DVR server icon on the map. (See [Add a DVR Server](#))
 - (7) Click **OK** to save the setting and exit the E-Map interface.
 - (8) Click **Cancel** without saving the setting and exit the E-Map interface.

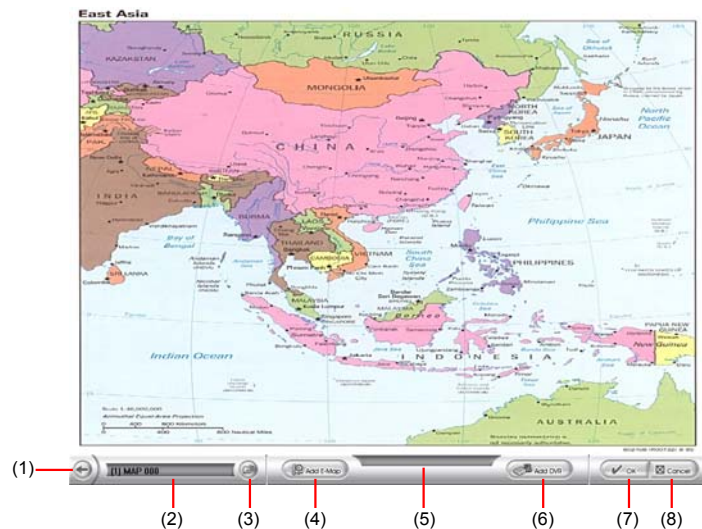

9.4.4.1.1 Add a New Map

1. Click  button
2. In the Authorization dialog box, enter the administrator User ID and Password
3. Click **E-Map** button
4. Click **Add Map** button and the **Map setting** window will show up.

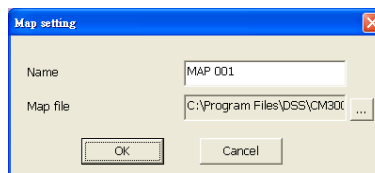

5. Give a name for the new map.
6. Click  to locate the map file. In the open dialog box, locate and select the map and click Open

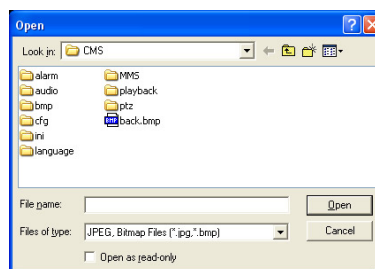

7. User may now drag and move the Map icon to its place on the map.
8. User can double click the Map icon to view the map.
9. To edit and delete the map, click the map icon and **Edit** and **Delete** button will appear on the Map interface. Click **Edit** to modify the map (see [Add a New Map# 5~6](#)). To delete the map, click the map icon and click **Delete** button.
10. Click **OK** to accept the new setting and **Cancel** to exit without saving the new setting.



- User can add up to a total of 64 maps
- User also can right click the mouse button on the map, a function list window will show up. User can select the function to add and modify the map.

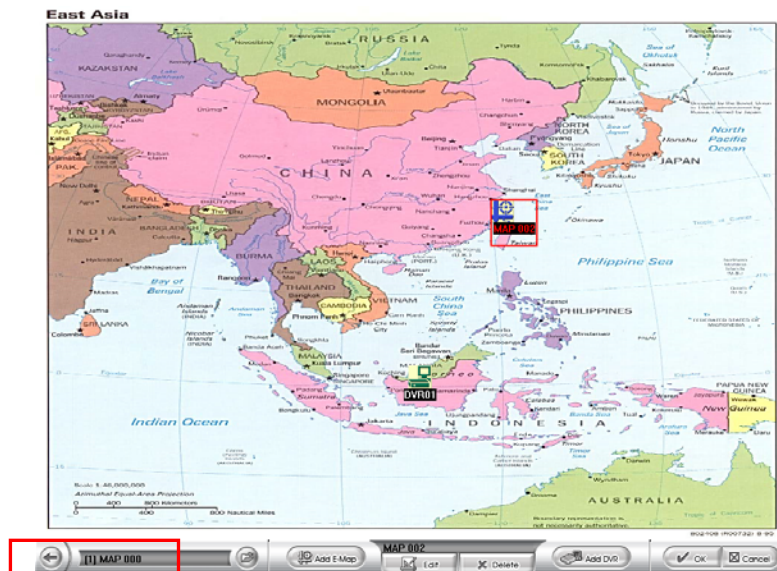

9.4.4.1.2 Add a DVR Server

1. Click  button
2. In the Authorization dialog box, enter the administrator User ID and Password
3. Click E-Map button
4. Click Add DVR button and the Add DVR window will show up.
5. Select the DVR server from the Add DVR window and click OK.
6. User may now drag and move the DVR icon to its place on the map. Non-active white DVR icon cannot be placed on the map.
7. To edit and delete the DVR server on the map, click the DVR server icon and the **Edit** and **Delete** buttons will appear on the Map interface. Click **Edit** to modify the DVR server (see [9.4.2.1 # 5~10](#)). To delete the DVR server from the map, click the DVR server icon and click **Delete**.
8. Click **OK** to accept the new setting and **Cancel** to exit without saving the new setting.



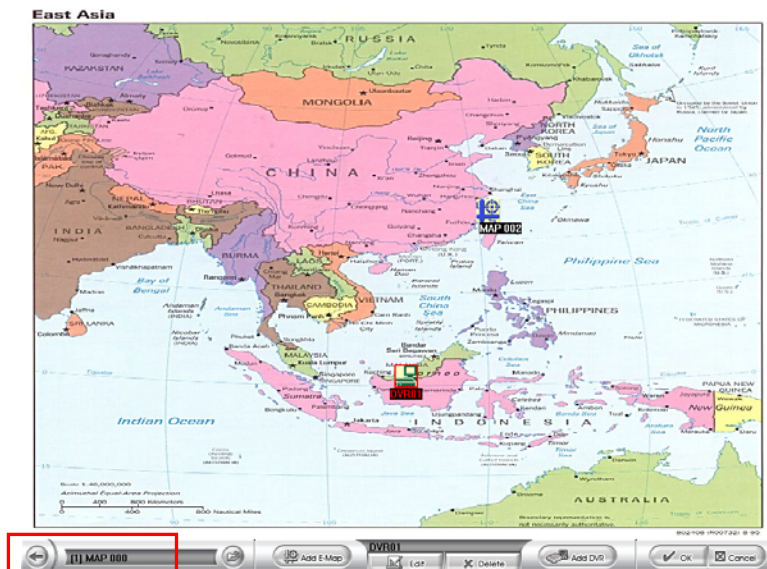



i User also can right click the mouse button on the map, a function list window will show up. User can select the function to add, delete, and edit the map.

9.4.4.2 To Use the E-Map

When the alarm has been activated, the DVR icon blinks and turns red.

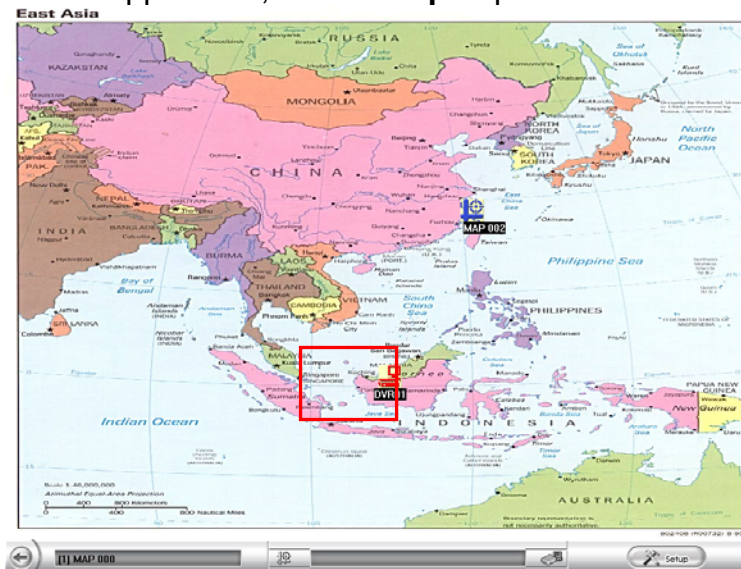
1. On the CMS main application, click **E-map** or press **F3**.



2. Click the DVR server icon and a **DVR watch** window will show up and connect the DVR server to play the live video.
3. To stop the DVR server icon from blinking, right click the mouse button and select **Reset Alarm** or **Reset Alarm (all)** and the remote DVR server alarm will reset and the DVR server icon will stop blinking.
4. To switch back to the main application, press **ESC**.
5. To setup the E-Map, click  button or right click the mouse button and select **E-Map setup** and the E-Map interface will switch to the E-Map setup mode. (see [9.4.4.1](#))

i When the setup mode is active in E-Map interface, the setup mode will not work in CMS main application.

To switch back the setup mode in CMS main application, click **OK** or **Cancel** to exit the setup mode in E-Map interface.

6. User can click the Map icon on the map to view the map. And the map can be added map on map and up to 64 maps. (see [Add a New Map](#)).

9.4.5 Alarm Setting

In the **Alarm Setting** dialog box, just select and enable the condition for the system to alarm and the action for the system to perform when an alarm is activated. User can setup a total of 16 different combinations of alarm settings. Each alarm setting can apply to several DVR servers. Click **OK** to accept new setting and **Cancel** to exit without saving.

9.4.5.1 To setup an alarm condition

1. Click the **Add** button to add a new alarm condition.
2. Give the name of this alarm condition.
3. Fill the simply description of this alarm condition in **Description** column.
4. Select the **Conditions**.
5. Select the **Action**. (see also [9.4.5.1.1](#) & [9.4.5.1.2](#) & [9.4.5.1.3](#))

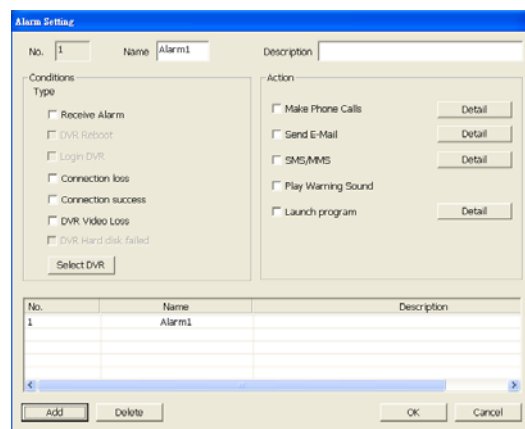

6. Apply to the DVR server, click **Select DVR**. In Select DVR window, select the DVR server and click **Add**. To exit and save the setup, click **OK**.

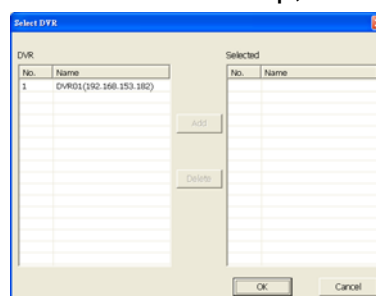

9.4.5.1.1 To Setup the Send E-Mail Setting

Beside the Send Email check box, click Detail. In the E-mail Setting dialog box,

click OK to exit and save the setting and Cancel to exit without saving the setting.

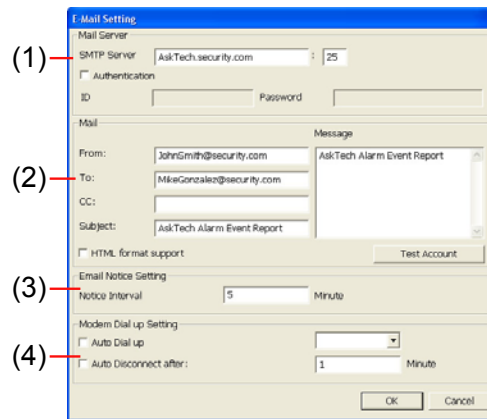

(1)Mail Server

Enter the SMTP Server and port. If your e-mail system requires user identification, enable the Authentication check box and enter User ID and Password.

(2)Mail

To check if it is working, click the Test Account button.

From: Enter the sender e-mail address.

To and CC: Enter the recipient email address and separate it with comma or a semicolon (;).

Subject: Enter the message title.

Message: Type the message.

(3)Email Notice Setting

In the Notice Interval text box, set the period of time before it sends another e-mail notice.

(4)Modem Dial up Setting

If you are using dial up modem, enable Auto Dial up check box and select the modem name. You may also set the time to disconnect automatically, just enable the Auto Disconnect after check box and set the time.

9.4.5.1.2 To Set the MMS/SMS Setting

To use this feature, GSM/GPRS modem is required. Connect the GSM/GPRS modem to the serial COMM port of PC. Beside the SMS/MMS check box, click Detail.

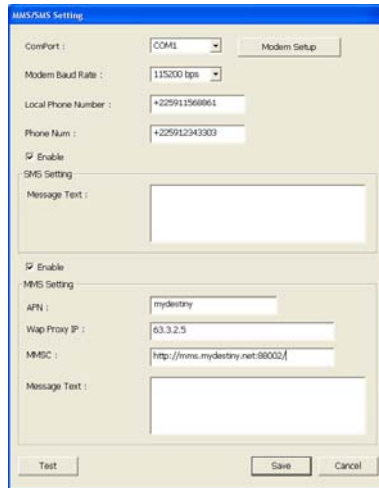

1. Select the port number in **ComPort** drop down list from where the GSM/GPRS modem is connected.
2. Click **Modem Setup** button to automatically detect the Modem Baud Rate.
3. In **Local Phone Number** text box, enter the GSM SIM card phone number.
4. In **Phone Num** text box, enter the contact number.
5. You may now set to send thru SMS &/or MMS. If you enable SMS setting, just enter the message in the text box. If you enable MMS, enter the APN name, WAP IP, MMS address and the message. If you are not sure, please contact your mobile service provider.
6. Click **OK** to accept the new settings and **Cancel** to exit without saving.

9.4.5.1.3 Launch the program

To call up the external program that is provided by a 3rd party. Click Detail and click **...** to locate the program path. Enable the **Multiple instance** check box if the external application has been programmed to execute repeatedly.

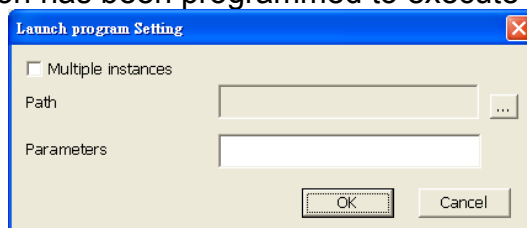

9.4.6 User Setting

CMS is limited to one operator and one administrator user account only. If there is an existing account, the old one will be replaced.

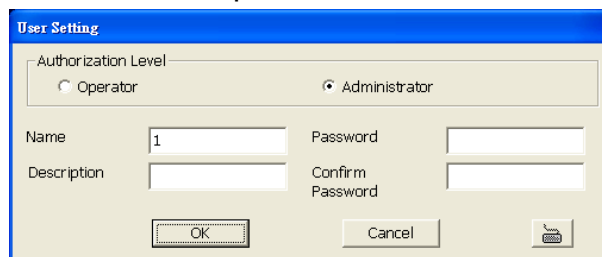

9.4.6.1 To Set the User Setting

1. Select the type of user. Only the administrator is authorized to close and customize the CMS system.
2. In the text box, enter the name, description, password, and confirm password of the user.
3. Click **OK** to accept the new settings and **Cancel** to exit without saving.

9.5 Using the Playback Function

User can choose to playback video stored on the local hard disk or download the video from the remote side of the DVR server.

9.5.1 To Playback the video

1. Click 
2. In the **DVR Playback select** window, select DVR server and **Local Playback** to play video from the local hard disk or **Remote Playback** from the remote DVR server.

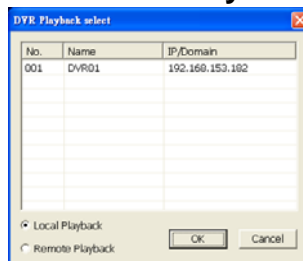

3. For Local Playback, user can select to preview 16 channels at a time. Only the cameras previously selected in **Monitor** and with the **Record** button enabled /recorded can be played back. In the Video Playback Date/Time Selection, the numbers from 00 to 23 represent the time in 24-hour. The numbers from 01 to 16 represent the camera number. The blue block indicates that there is a recorded video file in that period of time. While the red bar indicates the selected recorded video for viewing (see also [Chapter 9.5.2](#))

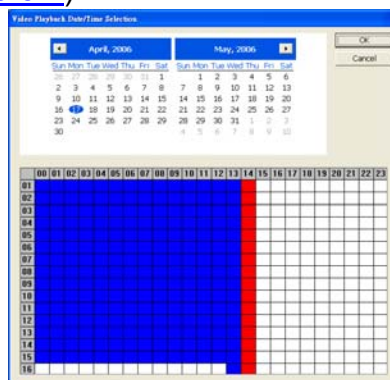

4. For Remote Playback, you can only select to preview one clip at a time. In the Remote Playback Date/Time Selection, the numbers from 00 to 23 represent the time in 24-hour. The numbers from 01 to 16 represent the camera number. The blue block indicates that there is a recorded video file on that period of time. While the red block indicates the selected recorded video for viewing (see also [Chapter 9.5.3](#)).

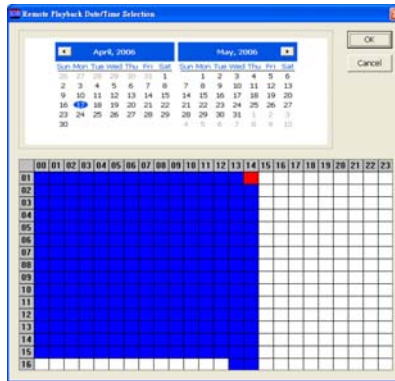

5. For Remote Playback, in Time Selection, click the frame you want to view.

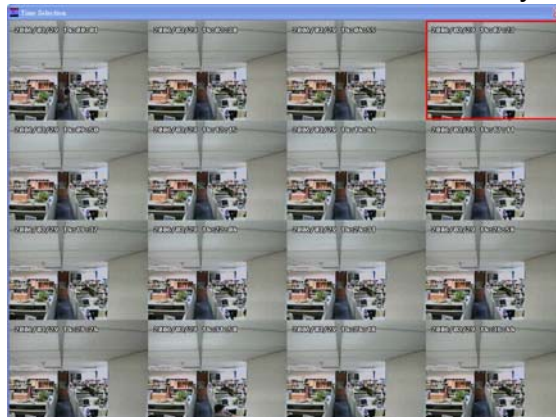

9.5.2 Using the Local Playback Application



Name	Function
(1) Split Screen Mode	Select from six (6) different split screen types to playback the recorded video file of all the cameras, or one camera over the other or alongside on a single screen.
i	<ul style="list-style-type: none"> - If there are only 4 cameras, you won't be able to switch to 9, 16, and 13 split screen mode. - To zoom into an area on the screen, Right click and Drag a square on the area you want to enlarge.
(2) Exit	Close the Player.
(3) Progress bar	Show the progress of the file being played. You may move the bar to seek at any location of the track.
(4) Hour Buttons	Select and click to playback the recorded video file on the specific time frame.
(5) Playback	Begin: Move to the beginning of the recorded video file.

Name	Function
Control Buttons	<p>Previous: Go back to the previous frame.</p> <p>Slower: Play the recorded video file at the speed of 1/2x, 1/4x, or 1/8x.</p> <p>Rewind: Wind back the recorded video file.</p> <p>Pause: Briefly stop playing the recorded video file.</p> <p>Play: Play the recorded video file.</p> <p>Faster: Play the recorded video file at the speed of 2x, 4x, or 8x.</p> <p>Next: Go to the next frame.</p> <p>End: Go to the end of the recorded video file.</p>
(6) Date	Select the date on the calendar and the time from 00 to 23 to where to start playing the recorded video file.
	The numbers from 00 to 23 represent the time in 24-hour clock. The numbers from 01 to 16 represent the camera ID. The blue colored column indicates that there is a recorded video file on that period of time. While the red colored column indicates on where to start playing the recorded video file.
(7) Status bar	Display the recorded date, time and play speed.
(8) Camera ID	Show the number of cameras that are being viewed. When you are in single screen mode, click the camera ID number to switch and view other camera.
(9) Output	Save the segmented file in *.mpg, *.avi, or *.dvr format (see also 4.3.1).
(10) Segment	Keep a portion of the recorded video you want (see also 4.3.1).
(11) Print	Print the screen shot.
(12) Snapshot	Capture and save the screen shot either in *.jpg or *.bmp format.
(13) Full screen	View in Playback-compact mode. To return, Right click the mouse or press ESC on the keyboard. When you switch to full screen in multiple-screen mode, Left click to toggle to only display one of the video in the multiple-screen mode or all.
(14) Visual Search	Search from a specific camera by Date, Hour, Minute, 10 Seconds and Second (See also 9.5.3.2).
(15) Find Next	Search for the next event or changes in the motion detector frame. You can use this when you are using Intelligent Search or Event Search only.
(16) Event Search	Search from the recorded activities that take place in the system (i.e., Sensor, Motion, Video Loss, POS) (See also 9.5.3.3).
(17) Intelligent Search	Search the changes in the motion detector frame (See also 9.5.3.4).

9.5.3 Using the Remote Playback Application

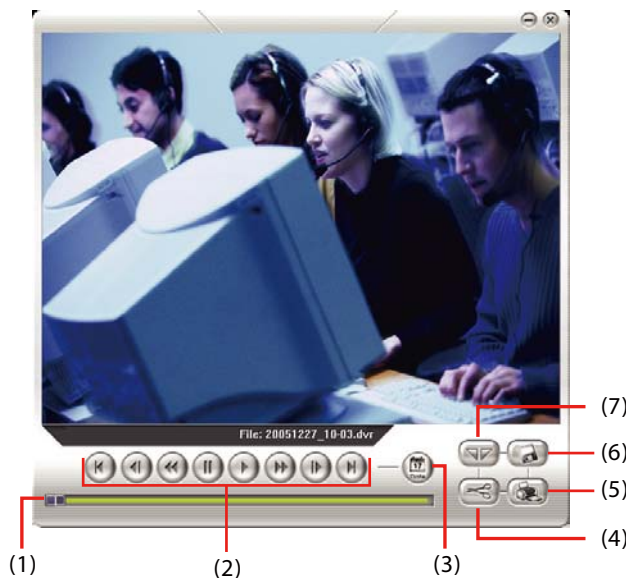

Name	Function
(1) Progress bar	Show the progress of the file being played. You may move the bar to seek at any location of the track.

Name	Function
(2) Playback Control Buttons	<p>Begin: Move to the beginning of the recorded video file.</p> <p>Previous: Go back to the previous frame.</p> <p>Slower: Play the recorded video file at the speed of 1/2x, 1/4x, or 1/8x.</p> <p>Rewind: Wind back the recorded video file.</p> <p>Pause: Briefly stop playing the recorded video file.</p> <p>Play: Play the recorded video file.</p> <p>Faster: Play the recorded video file at the speed of 2x, 4x, or 8x.</p> <p>Next: Go to the next frame.</p> <p>End: Go to the end of the recorded video file.</p>
(3) Date	Open other file.
(4) Output	Save the segmented file in *.mpg, or *.avi, format.
(5) Print	Print the screen shot.
(6) Save	Save the screen shot either in *.jpg or *.bmp format and video in *.dvr format.
(7) Segment	Keep a portion of the recorded video you want. You may follow the instruction in 9.5.3.1 .

9.5.3.1 To Cut and Save the Wanted Portion of the Recorded Video

1. Use the Playback Control buttons or drag the bar on the playback progress bar and pause on where you want to start the cut. Then, click **Segment** to set the begin mark.



2. Use the Playback Control buttons or drag the bar on the playback progress bar and pause on where you want to end the cut. Then, click **Segment** to set the end mark. To cancel segmentation or set the segment marks from the start, click **Segment** button again.



3. Click **Output** button to save the wanted clip.
4. In the Save As dialog box, locate on where you want to save the file, type the filename, and select the video format.

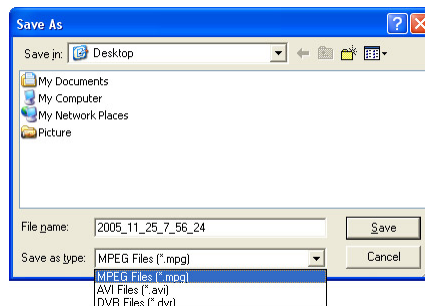

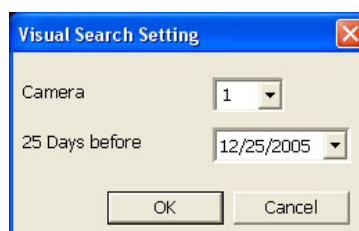

9.5.3.2 To Search Using the Visual Search

1. Click **Visual Search**.
2. In the Visual Search Setting dialog box, select the Camera number and the date. Then click **OK**.



3. When a series of frames appear by date, click on the frame to display another series of

frames and search by every Hour of that date, every Minute of that hour, every 10 Seconds of that minute, every Second of that 10 seconds. To go back, click . To view from the selected frame and close event search, click .



9.5.3.3 To Search Using the Event Search

1. Click on the video screen on where you want to search.
2. Click **Event Search**. The Event Search text (red) would appear at the lower left corner of the screen.
3. In the Event Search Setting dialog box, check the type of condition you want to search. If you select POS, in the Find Text box, type the word. Then, click **OK** to start searching. The video search would stop at the frame that matches the condition. To keep on searching, click .
4. You may also set to search and list all the result. Just check the **Output Event List** box. In the Search Duration section, set the **Begin Time**, **End Time** and **Searching Interval**. Then, click **OK** to start searching.
5. When the Event list appears, click and select the item you want to view.

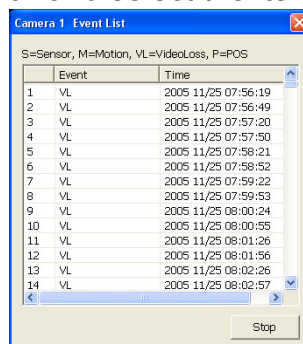

9.5.3.4 To Search Using the Intelligent Search

1. Click on the video screen on where you want to search.
2. Click **Intelligent Search**. The Intelligent Search text (red) would appear at the lower left corner of the screen.
3. When the Intelligent Search Setting dialog box and motion detector frame appear, you may adjust the sensitivity bar and the motion detector frame size and location. To set motion detector frame size and location, left click and drag on the screen. Then, click **OK**

to start searching. The video search would stop at the frame that matches the condition. To keep on searching, click . You may also set to search and list all the result. Just check the **List** box. In the Search Duration section, set the **Begin Time**, **End Time** and **Searching Interval**. Then, click **OK** to start searching.

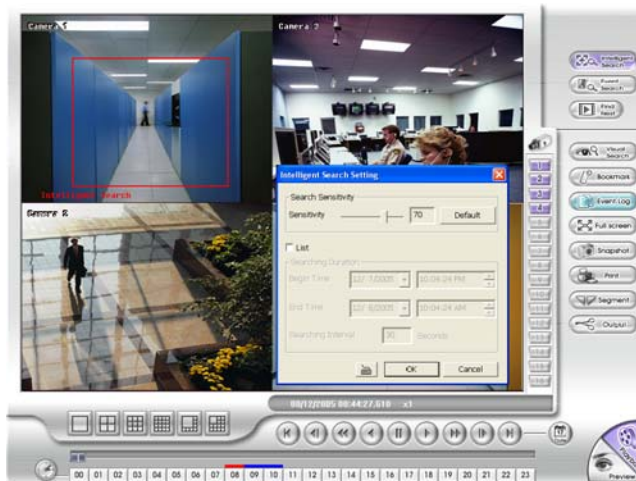

9.5.4 Using the Event Viewer

Show the record of activities that take place in the system. To filter the records, select and click the option button to only display Alarm, Motion, DVR Reboot, HDD fail, Login DVR, Connection Success, Connection Loss or All Event.

Click **Refresh** to update the list and **Save** to save the list in *.txt format.

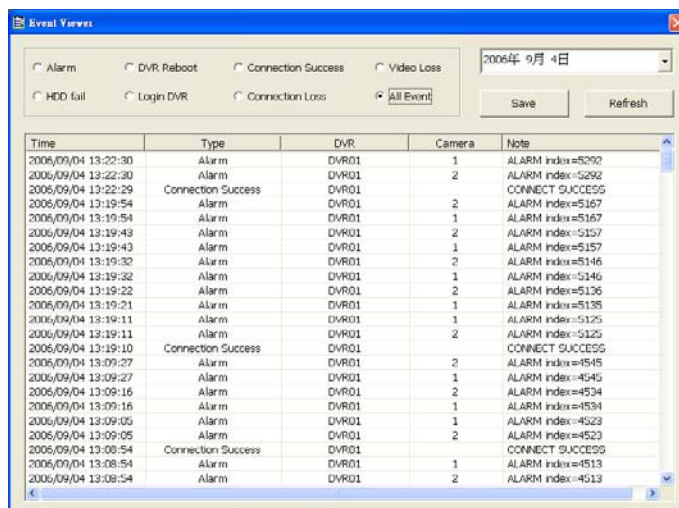

Appendix A Registering Domain Names

DDNS (Dynamic Domain Name Service) is a data query service mainly used on the Internet for translating domain names into Internet addresses. It allows remote clients to intelligently search dynamic servers without any previous enquiring for servers' Internet addresses.

In order to take advantage of this intelligent service, first register your domain name on the following Web site <http://ddns.avers.com.tw>

1. User Login

- Browse the website **ddns.avers.com.tw** with Microsoft IE or Netscape Navigator to access the following dialog.

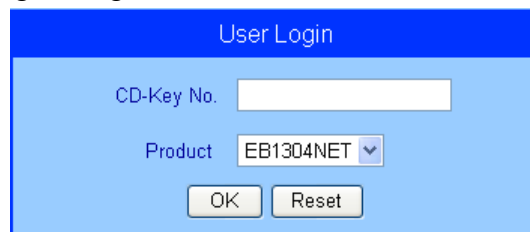

The 'User Login' dialog box has a blue header. It contains a text input field for 'CD-Key No.', a dropdown menu for 'Product' with 'EB1304NET' selected, and two buttons: 'OK' and 'Reset'.

- First input the MAC address of your DVR system as CD-Key number and select the product name. The CD-Key of MAC address input format shall be 12 digits without colon (:) or hyphen (-). To find MAC address of your DVR system, follow the steps below:
 - In OSD menu, select **NETWORK SETUP**
 - Select any one of IP mode
 - A **NETWORK INFORMATION** windows will show up
 - MAC address of DVR system is display as shown
- Then click **OK** to login or **Reset** to clear the previous input.

2. User Information

Please provide the following user information, **Host Name** (user can choose any name he/she likes except the one violence with other users), **Password**, **E-mail**, **Company**, and **Country**. And then, click **OK** to complete the domain name registration.

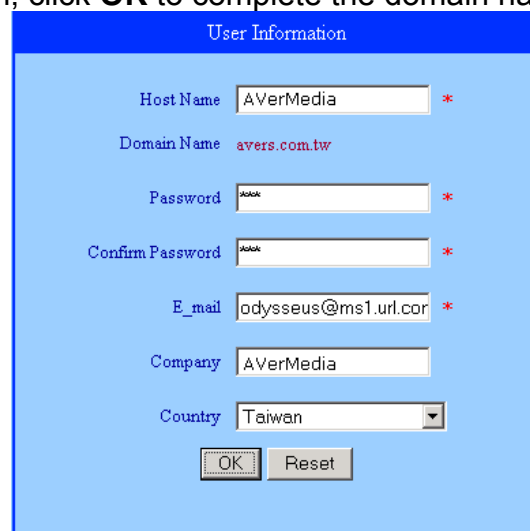

The 'User Information' dialog box has a blue header. It contains several fields: 'Host Name' (AVerMedia), 'Domain Name' (avers.com.tw), 'Password' (masked with asterisks), 'Confirm Password' (masked with asterisks), 'E_mail' (odysseus@ms1.url.cor), 'Company' (AVerMedia), and 'Country' (Taiwan). There are 'OK' and 'Reset' buttons at the bottom.

Appendix B Dual Monitors setting

Video configuration is different for each different VGA chipsets. Please follow the steps below to setup the dual monitors display.

Graphic card with ATi chipset

1. Enter the ATI Catalyst Control Center, user can click the short-cut or right click on the screen.



2. There are two modes to select — Basic and Advanced.



3. If user selected Basic mode, press the **Quick Settings** tab. Then select the **Select a different desktop mode** and click **Go**.

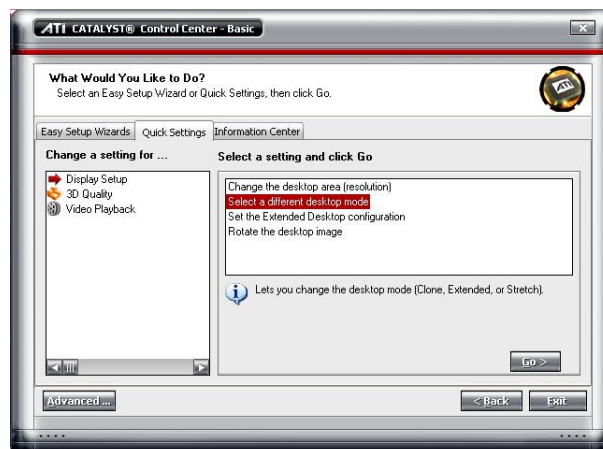

4. Select the **Extended Desktop** and then click **Finish**.

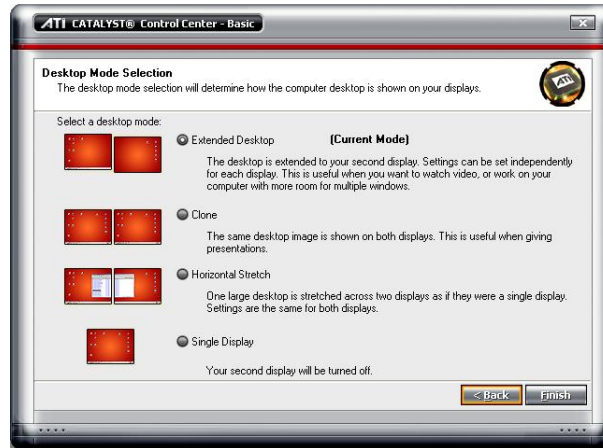

5. If user selected the Advanced mode, click the **View** button.
6. In **Display Manager**, right click on the second Display on the right side and select **Extend Main onto monitor**.



7. Adjust each monitor resolution to 1024x768.

Graphic card with NVIDIA chipset

1. Click the NVIDIA nView, and select the **Dualview** mode.
2. Adjust each monitor resolution to 1024x768.

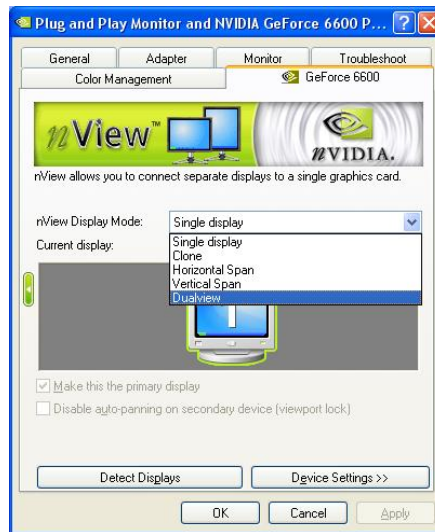

3. To review if the display mode is correct, you can check the task bar. The task bar will show on the first monitor only.



Monitor 1

Monitor 2

Appendix C Network Service Port

The following table shows the ports that DVR server uses for certain network service.

	Port#	Variable
Remote Console	80	Y
WebViewer	80	Y
CM3000	80	Y
Firmware Update	5005	Y
DVR DDNS (Upload / Download)	53/1053	N

Warranty Notice

LIMITED WARRANTY

AVerMedia TECHNOLOGIES, Inc. warrants this product to be free of defects resulting from faulty manufacture or components under the following terms:

WARRANTY LENGTH

Labor is warranted for (1) one year from the date of purchase

Parts are warranted for (1) one year from the date of purchase

Replacement products will be warranted for the remainder of the one year warranty period or (30) thirty days, whichever is longer

WHO IS PROTECTED

This warranty is enforceable only by the first consumer purchaser

WHAT IS AND IS NOT COVERED

Except as specified below, this warranty covers all defects resulting from faulty manufacturing of this product. The following are not covered by the warranty.

1. Any product on which the serial number has been defaced, modified, or removed
2. Damage, deterioration, or malfunction resulting from:
 - Accident, abuse, misuse, neglect, fire, water, lightning, or other acts of nature, commercial or industrial use, unauthorized product modification, or failure to follow instructions included with the product.
 - Misapplication of service by someone other than the manufacturer's representative
 - Any shipment damages (Claims must be made with carrier)
 - Any other cause which does not relate to a product defect
3. Cartons, cases, batteries, cabinets, tapes, or accessories used with product
4. AVerMedia does not warrant that this product will meet your requirements; it is your responsibility to determine the suitability of this product for your purpose

WHAT WE WILL AND WILL NOT PAY FOR

We will pay labor and material expenses for covered items. However, we will not pay for the following:

1. Removal or installation charges
2. Shipping charges
3. Any incidental charges

EXCLUSION OF DAMAGES

THE MANUFACTURER'S SOLE OBLIGATION AND LIABILITY UNDER THIS WARRANTY IS LIMITED TO THE REPAIR OR REPLACEMENT OF A DEFECTIVE PRODUCT AT OUR OPTION. THE MANUFACTURER SHALL NOT, IN ANY EVENT, BE LIABLE TO THE PURCHASER OR ANY THIRD PARTY FOR ANY INCIDENTAL OR CONSEQUENTIAL DAMAGE (INCLUDING, BUT NOT LIMITED TO, DAMAGES RESULTING FROM INTERRUPTION OF SERVICE AND LOSS OF BUSINESS) OR LIABILITY IN TORT RELATING TO THIS PRODUCT OR RESULTING FROM ITS USE OR POSSESSION.

LIMITATIONS OF IMPLIED WARRANTIES

There are no other oral or written warranties, expressed or implied, including but not limited to those of merchantability or fitness for a particular purpose. Any implied warranties are limited in duration to one year from the date of purchase

STATE LAW AND YOUR WARRANTY

This warranty gives you specific legal rights, and you may also have other rights granted under state law. These rights vary from state to state

CONTACT INFORMATION

Taiwan & International
No. 135, Jian Yi Rd., Chung Ho City, Taipei, Taiwan
TEL: 886-2-2226-3630
FAX: 886-2-22267241
Web Site: www.avermedia.com / <http://www.averdigi.com>